



AMANNGIRRBACH

CLASSIC
LAB EQUIPMENT

 **artex**[®]

 **giroform**[®]

LOOKING FOR SIMPLICITY,
PRECISION AND AFFORDABILITY?
WE UNDERSTAND YOUR NEEDS!



EFFICIENT
Workflow

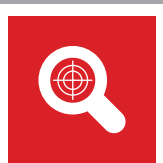

HIGHLY
PRECISE
Components



PERFECT
Handling

BENEFITS

- _ Cost-effective precision models for every laboratory
- _ Precision from A to Z for perfect work preparation
- _ Simple and user-friendly operation

FUNCTIONAL PRECISION CHAIN.

PRECISION MODEL



artex® facebow

Anatomically correct fixation of the cranium-axis relationship

- _Anatomically correct fixation of the skull-axis relation in only two minutes
- _Loss-free transfer of the oral situation to the Artex articulator
- _Reduces or saves grinding times on the patient due to highest precision



artex® cr

Precise, stable and proven 1000 times over

- _Provides all functions for analysing the free spaces and excursion patterns
- _Variable sideshift function for transversal clearance, adjustable
- _Light and stable due to carbon construction for optimum handling



giroform®

Precision models - fast and cost-effective

- _Outsmarts gypsum expansion and thus saves time-consuming grinding
- _Time savings by manufacturing the dental arch in only 6 minutes (working time)
- _Fault-free basis for digitalisation

PRECISION TRANSFER

DESIGN (CAD)
VIRTUAL OCCLUSION



ceramill®
DNA GENERATION



ceramill® map 600

ceramill® mind

ceramill® match 2

Speed of light. Artex precision.

- _Maximum precision through condyle-related scanning in the Artex workflow
- _Full jaw scan in 18 seconds provides maximum efficiency in the laboratory
- _Highest application safety through intelligent scan height control

The intelligent design software

- _High saving in time thanks to intuitive workflow according to dental technology logic
- _Virtual Artex CR with an unlimited range of functions
- _Perfectly coordinated with scan and CAM processes to guarantee a continuous workflow

CAM software - easy, quick, precise

- _Easy positioning and alignment of designs in the blank
- _Quick calculation of the milling paths
- _Sinter cushion in a thermodynamically optimum design shape for accurately fitting sintering of long-span zirconia restorations



Creates open STL data



Reads STL data (open), sends STL data (open)

Compatible with:

- _ iTero® intraoral scan data
- _ All other, unencrypted STL data



Reads STL data (open), sends STL data (open)

Compatible with:

- _ Dental Wings®, 3Shape®
- _ All other, unencrypted STL data

PRODUCTION (CAM)



ceramill® mikro

4- or 5-axis milling unit for dry millable materials

- _Maximum range of indications in the 4/5-axis dry milling/grinding category
- _Fast and efficient thanks to control and milling strategies optimised for dental applications
- _Monocoque design guarantees absolute stability and low-vibration processing



Processes and produces STL data (open)



ceramill® motion 2

5-axis wet and dry processing - versatile and future-proof

- _Maximum range of materials and indications
- _Innovative processing procedures ensure maximum ROI (Rotational milling of titanium, carving and thrilling grinding technology etc.)
- _Intelligent machine concept with high-performance, super-high-frequency spindle for maximum speed with the highest precision
- _Intelligent machine design guarantees optimum protection of all electronic components in wet operation



Processes and produces STL data (open)



NextDent™ 5100 for ceramill®

Revolutionary high-speed 3D printing technology meets the Ceramill System

- _High flexibility and production capacity due to high-speed Figure 4™ 3D printing technology
- _Precise, reproducible and repeatable results through validated fabrication workflow
- _Adapted to dentistry in the Ceramill workflow through "Integrated Indications"



ARTICULATION

≡ artex [®] system	8
≡ artex [®] facebow	10
≡ artex [®] articulators	12
≡ splitex [®] calibration	16
≡ artex [®] incisal guidance	18
≡ ceramill artex [®]	19

ARTEX SYSTEM - THE PERFECT COMMUNICATION BETWEEN DENTIST, DENTAL TECHNICIAN AND THE PATIENT

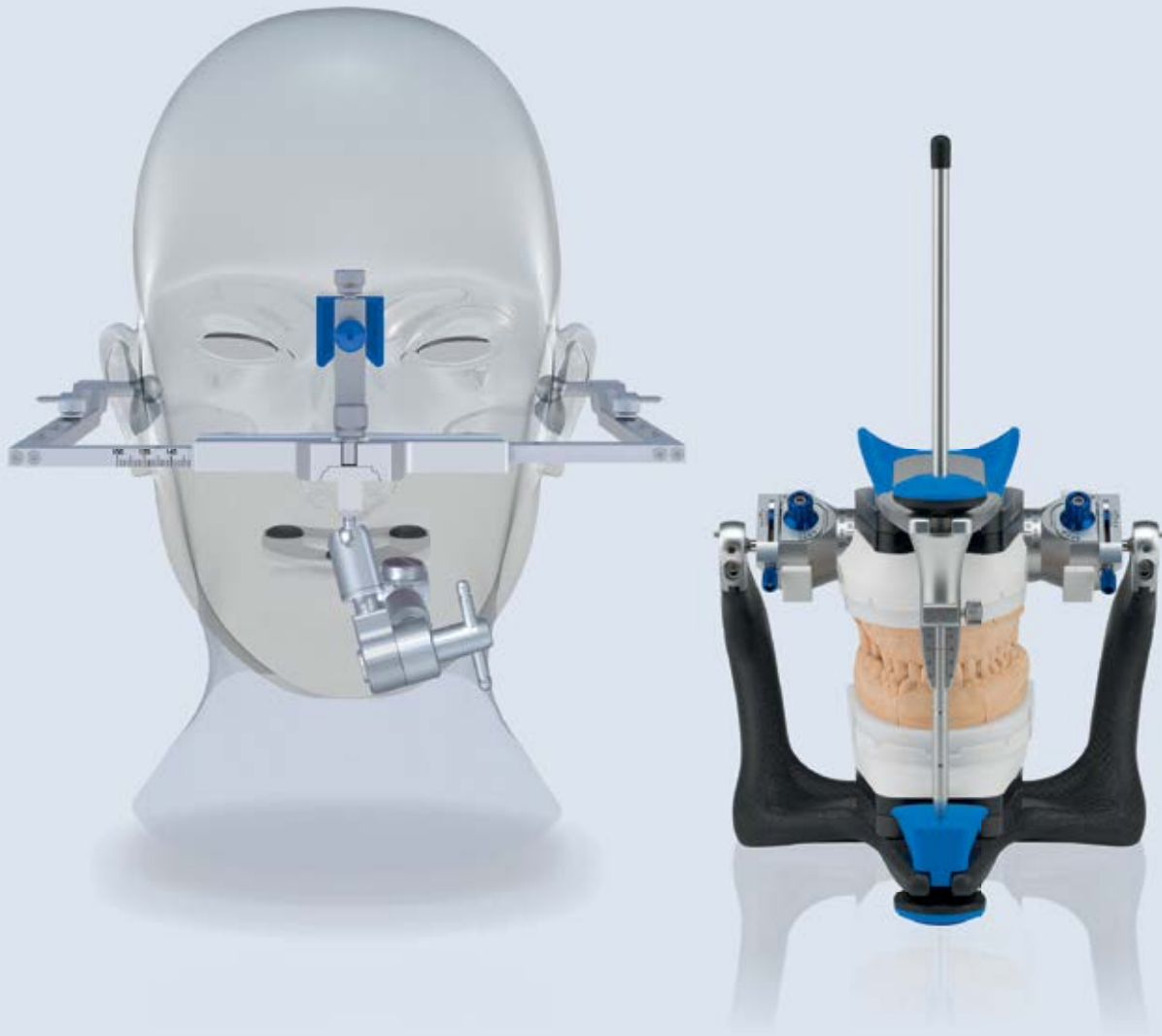

For maximum accuracy of fit for well-functioning dentures, working with an articulator is essential. The Artex system is renowned worldwide as being fully functional and reliable, and for dentists and dental technicians alike it is an effective aid in recording static jaw relationships and simulating jaw movements.

For the best possible link-up between dentist and dental technician.
For the ultimate in reliability and accuracy. For perfect service to the patient.

ARTICULATION SYSTEM COMPONENTS

artex[®] facebow

Determining the cranium/axis-related position of the maxilla.



artex[®]

Model management articulator and mastication simulator.



artex[®] transfer stand

Reliable and speedy transfer of patient data.



splitex[®]

Interchangeability of Artex articulators.



ANATOMICALLY CORRECT FIXATION OF THE CRANIAL-AXIS RELATIONSHIP IN JUST 2 MINUTES

Artex facebow, transfer jig and articulator form a single communication unit. Dentists determine the cranium-axis position of the maxilla using the Artex facebow. This anatomically important parameter is quickly and precisely fixed in position on the transfer jig. This secures it for transport from the practice to the laboratory where the models are mounted patient analogous in the Artex articulator.



- _ Cranium-axis oriented transfer of maxillary model to the articulator transfers the real jaw position precisely to the articulator and consequently reduces grinding time at the chairside**
- _ Reliable reproducibility of arbitrary axis position using cushioned Leipzig Nasion**
- _ Cranium/axis relation determined in corresponding to the patient's anatomy in just two minutes**
- _ Quick and secure the 3-D universal joint**



Bite fork insertion



Face bow attached to the patient



Removing joint support with bite fork record from the face bow

THE ARTEX FACEBOW - THE BETTER WAY TO OBTAIN AN ANATOMICALLY CORRECT REGISTRATION OF THE PATIENT'S CRANIUM/AXIS RELATIONSHIP



1 Preparation of the facebow: The nasion bar is secured in a rear position. Joint support inserted with its vertical position fixed by a wing screw



2 Prepare the bite fork in a double-boiler

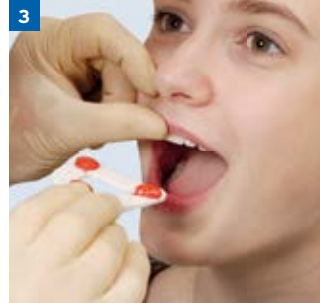

3 Introduce the bite fork into the patient's mouth



4 Position the bite fork at the dental arch of the upper jaw



5 Move the Artex facebow close to the patient's face



6 Introduce the ear tips into the external auditory meatus while sliding the sides of the facebow together and fix them in position by tightening the locking screw



7 Place the nasion adapter on the glabella by applying gentle thumb pressure till the marker on the nasion bar is reached. Patient is lying down



8 Fix the nasion bar by tightening the screw on the bar with your free hand



9 Move the joint support up to the bite fork and tighten the wing screw, thus securing the position of the upper jaw

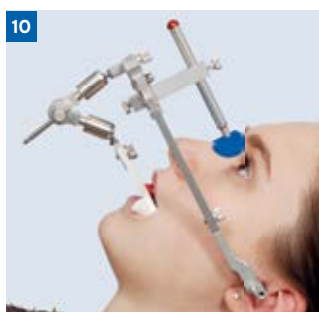

10 It takes only 2 minutes to apply the facebow



11 Remove the facebow and detach the joint support together with the bite fork registration



12 Fix the bite fork registration on a plaster bed on the transfer table for safe transport of the secured upper jaw position to the dental lab

SENSITIVE EXCURSION SIMULATORS - PRECISE, STABLE AND PROVEN IN 1000S OF APPLICATIONS

What the dental technician fabricates in the articulator must function intraorally. Artex articulators provide a highly precise option for accurately reproducing excursion patterns of patient receptors. Their light, stable design simplifies and accelerates work on the model while also reducing work on the patient and significantly increasing patient comfort.

Their reliable precision, flexibility and simple, ergonomic handling make Artex articulators one of the most commonly used mastication simulators in the world.

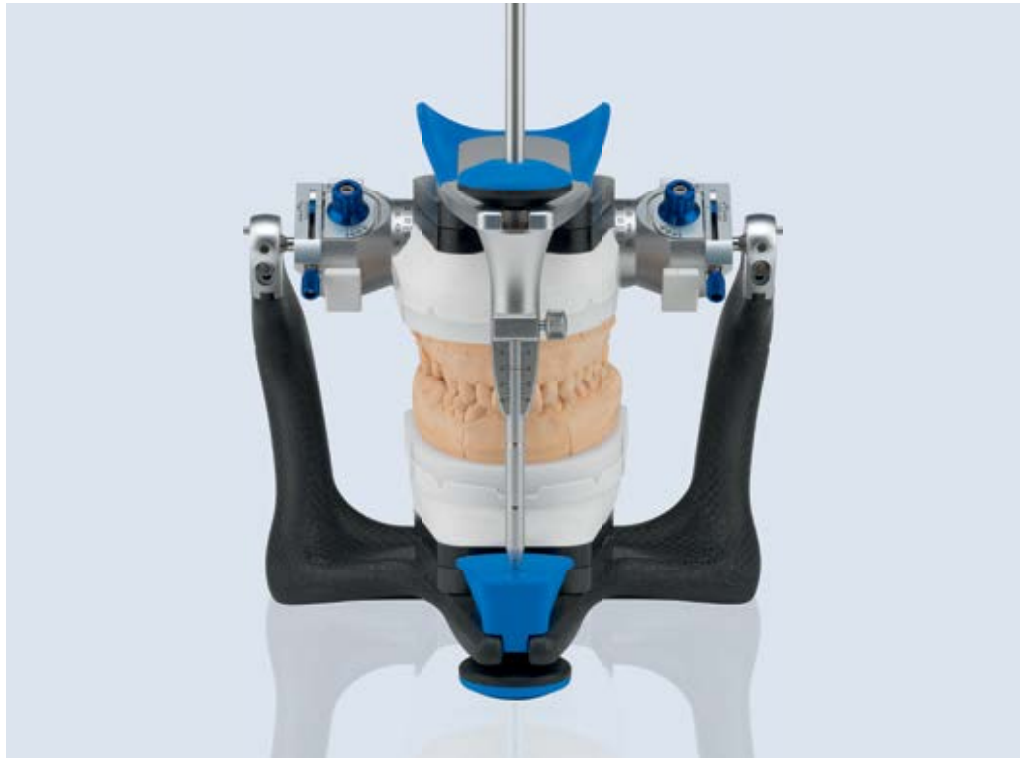

- _ **Integrated magnetic mounting plate system**
- _ **Interior height 126 mm - large working area, provides plenty of space for mounting models**
- _ **Bonwill triangle with 110 mm lateral length - formed from intercondylar distance and incisal point**
- _ **Average marking of the occlusal plane**
- _ **Scaled, adjustable incisal guidance pin (-5 mm to +10 mm)**
- _ **Support pin for opened upper member of the Artex articulator**
- _ **Light and stable thanks to carbon design (CN, CT, CPR, CR)**

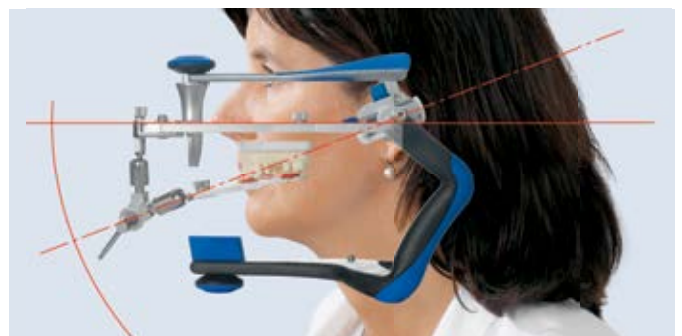

The reproducible centric guarantees a reliable start and end position of each excursion. Interferences less than 20 µm can be identified, checked and removed

Facebow and Artex articulators - the communication unit for patient-analogue restorations

ALL ARTEX ARTICULATORS AT ONE SIGHT

Technical Data Chart	Non Arcon-Design			Arcon-Design	
	Artex BN	Artex CN	Artex CT	Artex CPR	Artex CR
SCI (Sagittal condylar inclination)	35°	35°	-15° to +60°	-20° to +60°	-20° to +60°
Bennett-angle (HCI)	15°	0° to +20°	0° to +20°	-5° to +30°	-5° to +30°
Protrusion	-	-	-	-	0 to 6 mm
Retrusion	-	-	-	0 to 2 mm	0 to 2 mm
ISS (Immediate Sideshift)	-	-	-	-	0 to 1.5 mm (per side)
Distraction	-	-	-	0 to 3 mm	0 to 3 mm
Centric design	Centric click	Centric click	Centric click	Centric lever for semi-axes	Centric lever for semi-axes
Upper and lower articulator arms prevented from coming apart inadvertently in open centric by:	Centric plate	Centric plate	Centric plate	Arcon-Clip	Arcon-Clip
Arbitrary pins for direct transfer with Artex facebow	no	no	yes	yes	yes

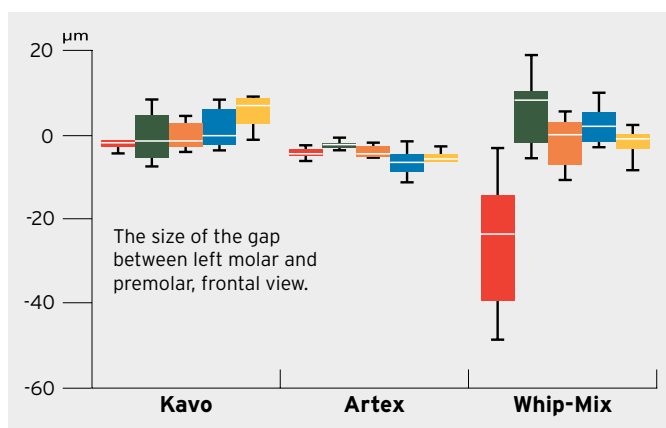

The high precision of the Artex articulators ensuring a perfect receptor fit in the patient's mouth has been impressively confirmed by a scientific study conducted at Tuft's University, Boston, MA, USA. All 4 Artex articulators (classic-version) have smaller dimensional deviations than comparable competitors.

Source: "Determining the accuracy of articulator interchangeability and hinge axis reproducibility", Panayiota Hatzl (DDS, MS), Philip Millstein (DMD, MS), Alvaro Maya (DMD, MSD) - School of Dental Medicine, Tufts University, Boston, Mass. Publishing: J Prosthet Dent 2001, 85:236-45

artex® articulators

IN NON-ARCON DESIGN

A feature of Artex articulators in non-Arcon design is their reliable and easy handling. In contrast to Arcon design articulators, the condylar ball is in the upper member of the articulator and the condylar guidance surface is in the lower member. The anatomy of the patient is thus "turned on its head", whereby upper and lower members of non-Arcon articulators form a single unit, even with opened centric.

artex® bn



NON-ARCON BASE DEVICE

- _ Precise functional components made from aluminium and stainless steel
- _ Integrated magnetic mounting plate system
- _ Fixed condyle with a 19 mm path radius
- _ Fixed average sagittal condylar path inclination of 35°
- _ Fixed Bennett angle of 15°
- _ "Click" - quick centric lock

artex® cn



NON-ARCON BASE DEVICE

- _ Simple and pleasant handling
- _ 3 working positions, no tipping over
- _ "Click" - centric quick lock
- _ Fixed average condyle track inclination at 35°
- _ Bennett angle adjustable from 0 to 20°

artex® ct



NON-ARCON BASE DEVICE

- _ Partially adjustable non-Arcon articulator
- _ Adjustable inclination of the condyle track inclination from -15° to 60°
- _ Bennett angle adjustable from 0 to 20°
- _ "Click" - centric quick lock
- _ Arbitrary pins for face bow adaptation

IN ARCON DESIGN

Artex articulators in Arcon design based on the human anatomy. The condylar balls are therefore in the lower member of the articulator and condylar guidance surface in the upper member. The condylar guidance elements can be adjusted using individual positioning registrations.

THE ARCON BASE DEVICE



- _ Semi-adjustable Arcon articulator with 3 non-tip working positions
- _ High-precision and robust centric quick lock via mechanically guided semi axis
- _ Arbitrary pins for direct transfer with the Artex facebow
- _ Adjustable inclination of the condyle track inclination from -20° to $+60^{\circ}$
- _ Distraction permitting release of compressed mandibular joints from 0 to 3 mm
- _ Arcon clip prevents separation of upper and lower articulator parts while centric is open
- _ Bennett angle adjustable from -5° to $+30^{\circ}$
- _ Infinitely variable retrusion, can be set from 0 to 2 mm

MODEL MANAGEMENT ARTICULATOR AND UNIVERSAL DIAGNOSIS AND THERAPY DEVICE



- _ Provides comprehensive adjustment possibilities to reproduce the patient's clearance and movement dynamics
- _ Fully adjustable Artex Carbon articulator offering the following additional functions:
 - _ Variable sideshift function for transversal clearance, adjustable from 0 to 1.5 mm (for each side)
 - _ Variable protrusion, adjustable from 0 to 6 mm
 - _ Variable retrusion, adjustable from 0 to 2 mm
- _ Distraction permitting release of compressed mandibular joints from 0 to 3 mm
- _ Ideal for model analysis, splint manufacture and correction
- _ Adjustable inclination of the condyle track inclination from -20° to $+60^{\circ}$
- _ Bennett angle adjustable from -5° to $+30^{\circ}$

PRECISELY INTERCHANGE ARTEX ARTICULATORS

All Artex articulators can be adjusted to uniformity of design using the Splitex key and Splitex plate set. The magnetic plate system is used for metric interchangeability. The precision of calibration is such that deviations are brought down to below 10 µm. This means that models can be mounted and changed with precision on any calibrated Artex.

Adjustability of the Artex articulators greatly simplifies model transfer between the practice and laboratory. Where both parties have a calibrated articulator, then only the models need to be transported, and not the complete articulator. Not only does this protect the articulator against handling problems, it also saves on postal charges.



- _ Highly precise interchangeability of Artex articulators thanks to tolerances below 10 µm**
- _ Saves articulators and increases their profitability**
- _ Simplifies dispatch (only the model) and increases the information flow**
- _ Splitex Counter plates prevent the risk of poor fit caused by plaster expansion and guarantee quick, precise adaptation to Splitex metal plates**



Splitex-keys



Splitex counter-plates in black or white



Splitex plate set for the carbon version

SPLITEX CALIBRATION



1 Remove model plates, magnets and magnet holders from the upper and lower parts of the Artex articulator



2 Replace the magnet holders by the mounting plates and secure them with screws in the upper and lower parts of the Artex articulator



3 Screw down the Splitex TOP plate on the upper part of the Artex articulator

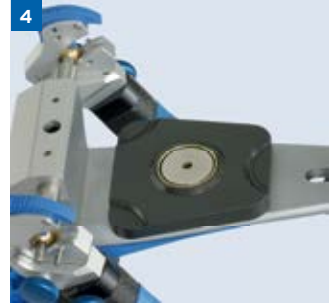

4 Insert the Splitex magnet holder and magnet into the TOP plate



5 Insulate the carbon surface in the area of the adhesive plate by applying a thin layer of petroleum jelly



6 Screw down the adhesive plate onto the lower part of the Artex articulator



7 Place the Artex articulator upside down and put Splitex key in place



8 Put Splitex mandibular adjustment plate on top of the key



9 Apply two strands of glue near the center of the Splitex plate



10 Close the Artex articulator and let the glue dry



11 Calibrate further Artex articulators using the Splitex key for metric commonality



12 Models can be transferred from one calibrated Artex articulator to the next as every dental technician and every dentist has his or her own Artex articulator

PROTECTS THE POSTERIOR TEETH AND GUARANTEES CORRECT INCISAL GUIDANCE

The Artex incisal guidance is used for fabricating functional anterior restorations, as correct incisal function is the prerequisite for a durable posterior restoration and preserving the residual posterior teeth. The incisal-canine guidance can be determined using the diagnostic models before grinding the teeth and transferred to settings of the customised incisal guidance unit.

Customised incisal guidance has been integrated in the Ceramill CAD/CAM system without limitations and is an integral component of the Ceramill Artex virtual articulator.



- _ Reproduces the incisal guidance of the patient**
- _ Guarantees correct incisal function and protects the posterior teeth against overloading**
- _ Avoids ceramic fractures due to overloading**
- _ Also practical for setting up guidance with posterior restorations**
- _ Avoids excessive grinding**
- _ Component of the Ceramill Artex virtual articulator**



Setting the customised incisal-canine guidance with diagnostic models - the posterior teeth disocclude



Prepared anterior with applied customised incisal-canine guidance



Customised incisal guidance table in the Ceramill Artex. The virtual and analogue techniques are identical

THE FUNCTIONAL INTERFACE BETWEEN MANUAL AND DIGITAL DENTAL TECHNOLOGY

With manual production of dental prosthesis working with the articulator is standard for dental laboratories. In order to achieve the same quality of the works virtually, it is only logical and consistent to enable this by means of a CAD/CAM system. The virtual articulator "Ceramill Artex" serves as a bridge between manual and digital techniques: The model pair in the Artex articulator is transferred to the Map400-scanner while holding the same Artex mode by means of the Ceramill transferkit; it is subsequently scanned-in in the appropriate proportion. The movement options of the Artex CR are thus synchronised digitally and manually. Interfering structures can already be removed, reducing time-consuming grinding in at the chairside to a minimum.

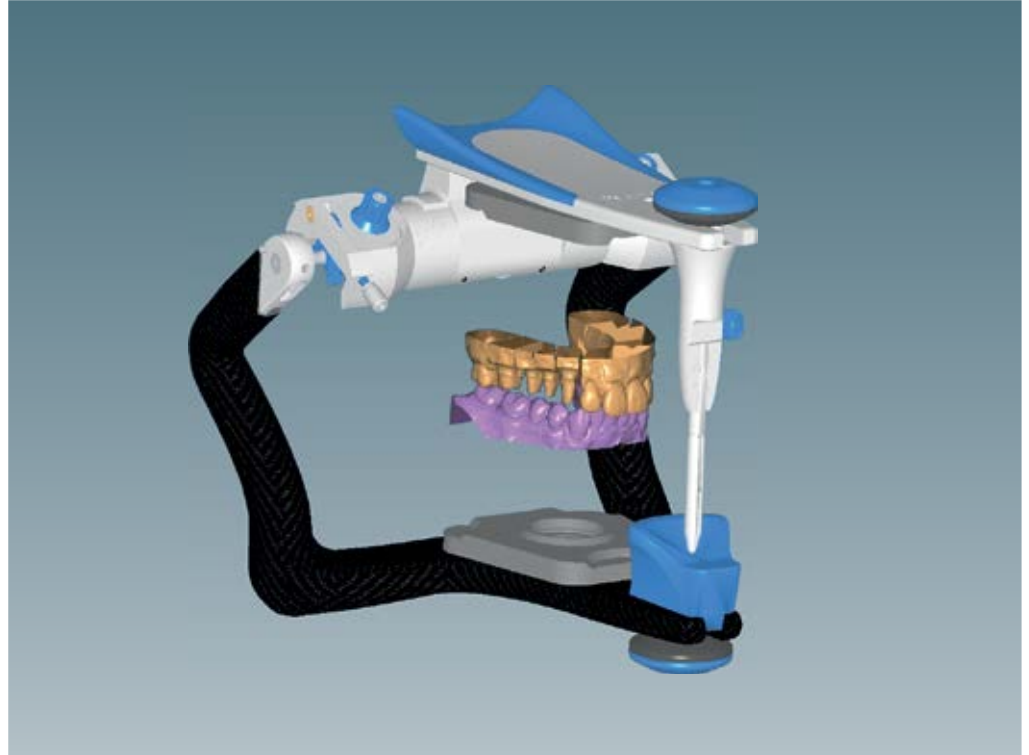

- _Virtual Artex CR for speedy entry into the digital world**
- _The virtual articulator offers the same functional scope as compared to the real Artex CR**
- _Ceramill transfer kit guarantees loss-free transfer of patient data to the scanner**
- _The calculation of the fully anatomical construction is dynamic and static under consideration of the antagonists and the adjusted values of the articulator**
- _Space for the porcelain built-up is automatically foreseen during the construction**



Models in the real Artex CR

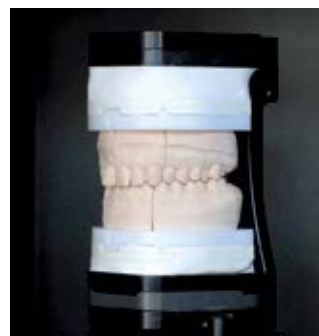

Model in the Artex Fixator







Adjustment modes at the virtual Artex CR

More about Ceramill Artex at
www.amanngirrbach.com/downloads



MODEL FABRICATION

 giroform® system	22
 alpenrock	31
STONES	32
 noflame® plus	33
 smartwax® duo	34

OVERCOMES PLASTER EXPANSION -
EASILY QUICKLY AND PRECISELY



The fitting accuracy of dental prostheses is largely dependent on the precision of the models. Yet this is the very area in which the natural expansion of the plaster constitutes the greatest source of error. The effects of plaster expansion are evident in the patient's mouth in problems with the fit of prosthetic work, such as tension areas. Giroform outsmarts the plaster expansion of the jaw segment, thus providing a true model of the patient's mouth. The Giroform System provides dental technology with a perfect and high-precision model making system on the market. By employing standardized and optimized procedures Giroform guarantees permanent and reproducible quality.

MODEL FABRICATION SYSTEM COMPONENTS

giroform® pin drill

Fabricate precision models precisely, easily and quickly.



giroform® base plates

Dimensionally stable plastic plates for impression-taking and overcoming plaster expansion.



giroform® secondary plates

Torsion-resistant and reusable splitcast plate with magnet.



giroform® duplicating flask

Model die duplication of individual segments.



FABRICATE PRECISION MODELS PRECISELY, EASILY AND QUICKLY

MODEL FABRICATION

The pin drill allows precise, fast and safe determination of the desired drill position.

Drilling starts at the press of a button. The plate holder is fastened magnetically, securing the drill position.

In order to guarantee pin friction, identical, smooth-faced and regular holes are drilled into the Giroform base plate. The precise drill guide also enables uniform drilling depth. These specific characteristics of the Giroform pin drill guarantee precise, fast and cost-effective model manufacture.



- _ Laser beam for easy drill positioning**
- _ Plate holder smoothly adjustable thus ensuring safe and fast operation**
- _ Plate holder is secured magnetically and automatically when drilling starts**
- _ Automatic drill advance guarantees identical boreholes in the plates (0.5 seconds per drill cycle)**
- _ Ergonomically positioned tip-on buttons for a high degree of operating convenience and easy activation of drilling**
- _ Guide grooves ensure easy drill change**
- _ Universal plate holder for all sizes and shapes of Giroform baseplates with anti-rotation protection**



Strong, practical and aesthetic - stainless steel housing



Laser beam for easy drill positioning



Plate holder is secured magnetically and automatically when drilling starts

DIMENSIONALLY STABLE PLASTIC PLATES FOR MODEL FABRICATION WITHOUT PLASTER EXPANSION

Using the Giroform base plate means that the model is already half finished. The base plate is expansion-resistant, saves one working step and prevents plaster expansion.

Prior to using the plaster, the pinhole is set into the base plate, recording the position of the individual segment.

The high-precision homogenous plate material provides for smooth drill holes and guarantees precise pin guidance.

The flat surface of the base plate enables simple control of the segment position via an easily recognizable light gap. Cost-effectiveness is further increased by the possibility to re-use the base plate and the retention disc.

Saves working time (base plaster, sleeves and moulds). Base plate ready-to-use and available in three sizes

- L for standard cases
- XL for exceptionally large arches
- Quadrant for sectional impressions

Multiple-use of premium plates for opposite models and classic plates
three drill holes for pin fixing if working without a metal disc

Cost savings
low-priced reusable metal discs for classic base plates

Split cast checked for scientifically verified geometry
triangular split cast with wedge tapering to centre

Screw fitting no longer required saving time
premium base plates incl. metal discs

Labels in diagram: quadrant, large, X-ray type

- _ Using the Giroform base plate means that the model is already half finished
- _ Inherently stable base plate instead of the risk of secondary plaster expansion due to base plaster
- _ Plate material and the plate strength provide for precise pin guidance
- _ Only minimal amounts of dental arch plaster required
- _ Flat base plate surface enables individual segment monitoring at a glance
- _ Inclined rear surface facilitates insertion in the plate holder and model removal from the articulator
- _ Base plate can be re-used for opposing model



Individual segments checked at a glance. Plane surface of the base plate



Multiple usage of used baseplates for opposing dentition models and unscrewed metal plates as retention discs for diagnostic models



Slanting facilitates insertion in drill plate holder and removal from articulator

OVERCOMING PLASTER EXPANSION

UNDESIRABLE PLASTER EXPANSION IN MAKING THE MODEL:



1 The patient's original mouth position



2 The tooth arch following plaster expansion



3 By superimposing the original and the expanded tooth arch, the deviation is clearly shown

HOW DOES GIROFORM SOLVE THIS CHALLENGE?

Defeat expansion with Giroform
= Eliminate tensions from prosthetic work



4 The pin positions are chosen taking this cast into account. By drilling the pin-holes, there is secure and immovable patient-analogous transfer to the dimensionally-stable Giroform Plate. The pin-holes ensure that the positional information is now stored. The Giroform Base Plate serves as a kind of memory stick



5 The cast plaster tooth arch is removed from the base plate after 30 minutes - i.e. before the onset of plaster expansion. This allows the tooth arch to expand freely. However, after this it no longer matches the drilled original information on the Giroform Plate



6 After sawing or separating the tooth arch, the pins again fit into the drill-holes. The cut section serves as an expansion joint to accommodate the expansion, which is now restricted to just the individual segments, thus no longer causing distortion of the tooth arch. The segmented model therefore offers a precision basis for perfectly-fitting work

THE SYSTEM WHICH SAVES DOUBLE THE TIME

THE SYSTEM THAT SAVES TIME AND MATERIAL

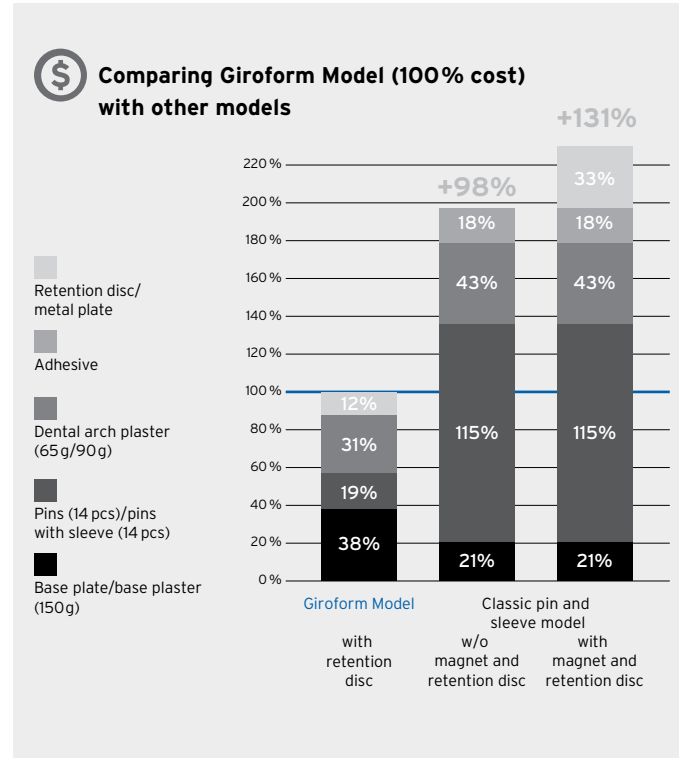
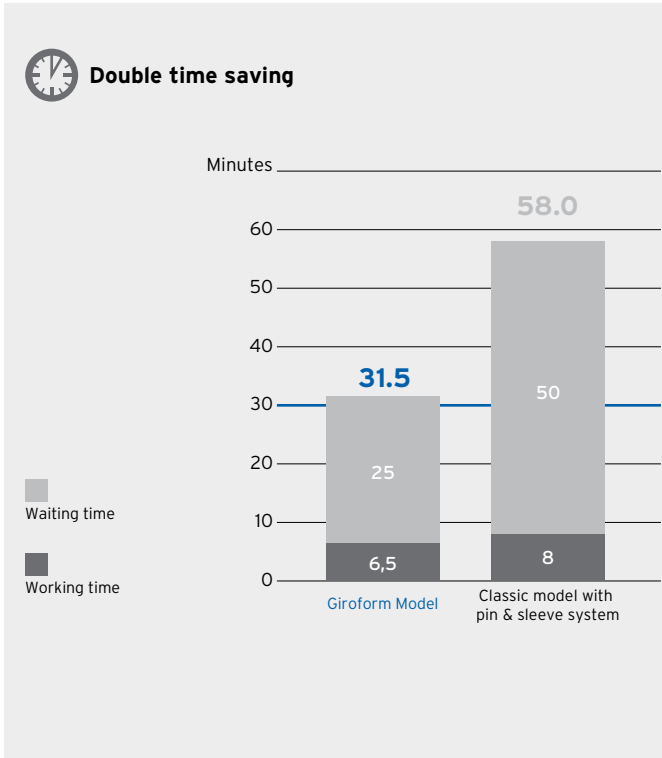

MODEL FABRICATION

- _ The actual time required to make the model is just 6-7 minutes
- _ The base is already completed due to the dimensionally stable Giroform base plate and does not require any curing time
- _ Segmentation of the dental arch can commence after a little more than 30 minutes

- _ The amount of plaster needed is reduced due to blocking out the impression with Giroform putty
- _ The metal disc is already fixed into the premium base plate
- _ Multiple use of base plates, secondary plates and metal discs
- _ Base plaster no longer required
- _ The base plate is cheaper than the base plaster
- _ No adhesives, guide sleeves or shell moulds required

FROM THE IMPRESSION TO THE FINISHED, HIGH-PRECISION GIROFORM MODEL AND APPLICATION IN THE ARTEX* ARTICULATOR

MODEL FABRICATION



1 Trim the impression (working model)



2 The impression is fixed onto the impression carrier with Giroform - putty, align the impression and putty insulation is trimmed



3 With the Giroform base plate inserted, the impression carrier is attached to the plate holder



4 Position drilling hole with the aid of the laser beam and initiate drilling procedure

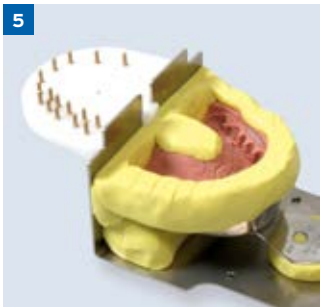

5 When the Giroform pins have been inserted into the drilled holes, the base plate is put aside for later use. (Important when multiple models are produced)



6 Trimmed impression of the opposing jaw on impression carrier, while the holes for the 8 pins are drilled for the counter bite



7 Mark out the selected drilling hole on used base plate (multiple usages)



8 Used plate with drilled holes and pins for opposite bite



9 Smartbox - push button for water and plaster powder dosage



10 Smartmix mixes the dental arch plaster



11 Upper and lower jaw prior to stone pour in each case with pinned bases

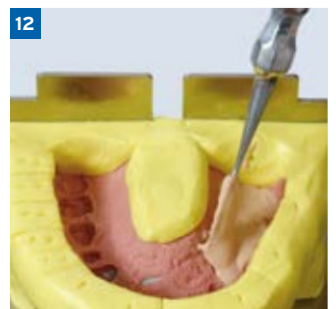

12 Fill the alpenrock eliminating any voids into the impression model - only to the top of the putty insulation

*Method can be used for patients with optimally functioning pre-condition



13 After 30 minutes, the dental arch is detached from the base plate



14 Partition/saw tooth arch into segments (Tip: in order not to damage the tooth arch, first separate the tooth arch in the middle)



15 Giroform model pair



16 At the dental lab, the transfer table is placed in the articulator or the special mounting articulator used as a plastering device



17 Artes CR with inserted upper jaw model



18 Giroform-Models were articulated in static occlusion using a face bow registration



19 Mark out the grinding facets on the occlusion with a pencil



20 Reduce the master model for height analysis. Remove all segments up to the neighbouring teeth from the model



21 Open the side shift setting screw to open the ISS. Set the anterior guidance pin out of contact



22 To determine the height the antagonists are put into their deepest position alongside one another. Articulator centric is open



23 Re-insert the other segments and remove the segments that determine the height. Use articulating film to mark out and adjust any premature contacts - with the centric articulator relation closed



24 Check the dynamic occlusion - lateral motion. Are the abrasion facets on the teeth close to the restoration area providing guidance now?

FABRICATE PRECISION MODELS ECONOMICALLY AND QUICKLY

giroform® secondary plate



STABILITY AND COMFORT

- _ Split cast check enables passive (non-magnetic) precision fit to the base plate
- _ The balanced magnetic force and high material strength prevent deformation
- _ The retention pattern on the rear has been optimized to provide excellent grip for the plaster during insertion in the articulator but also its easy removal after use

giroform® quadrant plate



STRAIGHTFORWARD AND VERSATILE

- _ The standardized plate size is ideally suited to partial impressions - both left or right quadrant casts. No more trimming or grinding required
- _ Drill holes for pins can be positioned at underside and will thereby facilitating insertion, casting and removal from the articulator
- _ The Vertex® adapter enables direct connection to Vertex® articulators
- _ Also adaptable with the Orbix system with minor alteration

giroform® duplicating flask



PRECISE AND ECONOMICALLY PRICED

- _ Precision brass pin
- _ With smooth finish on tapered section for accurate fit in base plate hole
- _ With active retention area for perfect grip in dental arch plaster
- _ Reasonably priced

SUPER HARD GYPSUM FOR THE OPTIMAL FABRICATION OF PRECISION MODELS

The super hard Class 4 gypsum is suitable for the production of tooth arches, single stumps and control models. Processing and expansion properties perfectly match Giroform model production processes.



Gold



Pastel



Saffron



Grey

- _ Expansion properties (hardening expansion of only 0.08%) perfectly match Giroform model production**
- _ Splinter-free processing and high pressure-resistance**
- _ Easy pouring due to shaker effect**
- _ Stable without shaker effect (thixotrop)**
- _ Comfortable processing through snap-set**
- _ Extremely long 7-minute processing period**
- _ Rapid completion of hardening after 12 minutes**
- _ Rapid final hardness after 35 minutes**
- _ Possible to scan, e.g. for strip light scanners such as the Ceramill Map**



Four colours: pastel, saffron, gold, grey (see illustration above)



4 kg bag - economical storage-stable package size





Easy to handle

STONES

ALL STONES AT ONE SIGHT

Technical/physical data:



Application	Dental arch, precision sectioned models	Dental arch, precision sectioned models	Situation model Opposing jaw	Situation model Opposing jaw	Plaster for full denture prosthetics	Articulation plaster
Product	Alpenrock High-strength dental stone	Girocko Synthetic Superstone	Girostone Synthetic Superstone	Girodur Synthetic Superstone	Giroplast Synthetic Superstone	Artifix Synthetic plaste
						
Class	4	4	4	4	3	3
Colour	gold, pastel, saffron, grey	gold, grey	rosé, pastel, yellow	white	blue	white
Mixing ratio (Powder : Water)	100 : 20	100 : 20	100 : 22	100 : 23	100 : 30	100 : 30
Sprinkling time (s)	15	10-20	15	15	15	15
Soaking time (s)	30	10-20	30	30	30	30
Mixing time in vacuum (s)	30	30	30	30	30	30
Working time (min)	7	5-6	6	5	4	3
Setting time (min)	12	12	10	10	10	4
Remove from the impression (min)	35	40	35	30-45	30-45	-
Linear setting expansion						
after 2 h	0.08		0.10	0.10	< 0.20	0.03
after 24 h		0.10	0.13			
Compression strength EN 26873 (MPa)	59	> 60	60	< 50	30	20
Hardness (MPa)	262	> 250	180	< 150	80	50
Bending tensile strength (MPa)	12	8	8	7		5
Content (kg)	20 (5x4)	20 (5x4)	20	20	20	20
Order no.	711110 711120 711130 711140	711160 711161 711170 711171	711021 711022 711023	711105	711050	711217

SIMPLE, MOBILE, CLEAN - THE "ELECTRIC BUNSEN BURNER"

With the Noflame Plus it is no longer necessary to use conventional Bunsen burners or alcohol/gas burners when waxing up. The waxing up instrument is heated in the coil opening by induction in a matter of seconds using minimum energy consumption. This excludes carbon collecting on the waxing up instrument or in the sculpting wax. Standard waxing up instruments can be used.



- _ Mobile and immediately operational, no gas required**
- _ Handling as usual, no adjustment required**
- _ Eliminates the risks of getting burned or causing fire**
- _ No heat emission into the environment; does not consume oxygen**
- _ Clean, i. e. no soot particles on instrument and/or material**
- _ Saves 75 % of energy expenses; saves the environment**
- _ Ideal conditions, to be used even at the dental office**



Within seconds, the modelling instrument is heated in the coil opening



Replaceable protective caps keep the coil opening clean

EFFICIENT MODELING STATION FOR WORKING WITH TWO HANDPIECES

MODEL FABRICATION

This unit is suitable for all kinds of modeling and wax-up work and is unbeatable in combination with the Waxjet when making full dentures. For each handpiece, 3 different temperatures within the range of 50-220°C / 122-428°F can be programmed and simply switched over. This improves the soft and above all stress-free treatment of the various types of waxes.

In doing so, the excellent thermal conductivity of the instrument alloy used for the probes (more than 20 times the thermal conductivity of stainless steel) plays an important role as well.



- _ Duo-option, i.e. two different handpieces are ready for use at the same time**
- _ 3 individually programmable temperatures for each handpiece**
- _ Simple and safe exchange mechanism of the modeling tips**
- _ Fast operational and heated instruments**
- _ Anti-twist cables that are insensitive to heat**
- _ Gold plated copper tips for better heat conductivity**



Change of probes without the risk of burns - snap on, snap off



Simple adjustment of individual working temperature



Waxjet available as an optional device

DOSING, MIXING, CLEANING

≡ smartbox X2	36
≡ smartmix X2	37
≡ steamer X3	38

PLASTER CANNOT BE SIFTED MORE EFFICIENTLY

The Smartbox X2 guarantees the consistently high quality of the dosing result and is easy to use. Due to its high savings potential, the machine pays for itself in just a few months.

With its patented dosing technology, the gypsum is sprinkled very finely into the mixing bowl, which significantly improves the homogeneity of the mixed material..

DOSING, MIXING, CLEANING



- _ Time, material and plaster savings of 20 to 25%**
- _ Finely sprinkled plaster using the patented plaster dosage technology**
- _ Easy operation - error-free working for everyone**
- _ Reproducible mixing ratio at the push of a button, accurate to within a gram**
- _ Integrated scales automatically measure the dosage or for manual weighing**
- _ Enables clean and dust free operation**



Easy to fill the silo at the machine



One switch for everything - multi-functional dial / button



Fine plaster curtain due to new dosage technology

PERFECT MIXTURE RESULTS THANKS TO PATENTED MIXING BLADE GEOMETRY AND AMAZINGLY SIMPLE OPERATING CONCEPT

The universal and future-proof vacuum-mixing machine with the amazingly simple operating concept.

No matter whether for the rapid production of homogeneous plasters, investment materials or paste-like silicones.



- _Homogeneous and reproducible mixing results with optimal parameters**
- _Fast access to all storable mixing parameters such as mixing time, speed, direction of rotation, interval time, premixing, pre-evacuation, post-vacuum and program name**
- _Easy handling for fast program selection and programming**
- _Space saving, can be used as a free-standing or wall unit**

Smartmix mixing beaker

The patented mixing blade geometry of the Smartmix mixing beaker ensures optimal mixing results in all areas of application. By means of both horizontal and vertical revolution of the materials to be mixed, perfect homogeneity of mixture results is achieved



Rounded beaker base for easy cleaning



Patented mixing apparatus geometry, mixing speed up to 550 U/min



Post-vacuum-function

UNIVERSAL STEAM CLEANER

The Steamer X3 is a high-quality, universal steam cleaner for cleaning small objects such as metal frameworks and dies as well as articulators or instruments.



- _ Large stainless steel tank with 3.7 liter capacity**
- _ Efficient and reliable cleaning at 4 bar and 140 °C**
- _ Highest reliability due to the use of high-quality components**
- _ Clear function display, e.g. the minimum water quantity**
- _ Smooth, rounded surfaces for easy cleaning**
- _ Drain valve positioned at the very bottom guarantees complete rinsing of limescale deposits in the tank**
- _ Floor mounted or wall mounted**



Steamer X3 is filled without funnel



The ergonomic hand piece is always within reach



Sealing lid without vulnerable pressure control valve

CASTING

≡ giro bond nbs	41
≡ giro bond cbs	42
≡ giro crom fh	43
≡ giro invest speed	44
≡ giro invest super	45
≡ af 350	46

ALL ALLOYS AT ONE SIGHT

	CoCr-alloy		
	Bonding alloys		Model casting alloys
Product name	Girobond NBS	Girobond CBS	Girocrom FH
Description	The proven classical alloy: carbon-free CoCrMo bonding alloy	Modern NiCrMo bonding alloy for crown and bridge work	The ideal CoCr model casting alloy
Features	<ul style="list-style-type: none"> _ Excellent laser welding behavior, no risk of crack development since carbon-free _ High homogeneity within the batches and good reproducibility thanks to the optimized production process _ Suitable for casting with any standard method _ Dense surface, good polishability, rich shine 	<ul style="list-style-type: none"> _ Low hardness (185 HV10) _ High strength _ Good melting and casting properties _ Carbon-free, thus perfectly suitable for laser welding 	<ul style="list-style-type: none"> _ Extra-hard quality, fracture-resistant clasps _ Suitable for modelling delicate frameworks _ Easy to model and polish (fine-grained structure) _ Carbon-free, thus perfectly suitable for laser welding
Technical/physical data			
Proof stress Rp 0.2 % [MPa]	620	400	700
Tensile strength Rm [MPa]	850	650	880
Modulus of elasticity E [GPa]	210	180	220
Elongation at rupture A [%]	14	45	5
Vickers hardness HV10	330	185	350
Casting temperature [°C]	1510	1410	ca. 1450
Melting range Solidus [°C]	1350	1270	1346
Melting range Liquidus [°C]	1422	1356	1388
Density [g/cm ³]	8.6	8.4	8.2
CTE 25-500 °C [x 10 ⁻⁶ K ⁻¹]	14.1	13.8	
CTE 25-600 °C [x 10 ⁻⁶ K ⁻¹]	14.3	14	
Chemical composition in % by mass			
	Co 62.4	Ni 63.5	Co 59
	Cr 25.5	Cr 24	Cr 32
	Mo 5.1	Mo 10	Mo 6
	W 5.2		Si 1.3
	Si 1.1	Si 1.5	
Other < 1 %	Nb, Fe, N	Nb, Mn	Mn, N, Nb, W
	CE-certified and free of nickel, beryllium, gallium and carbon		
Packs			
1000g Laboratory pack	781610	781690	721250



MODERN NICRMO BONDING ALLOY FOR CROWN AND BRIDGE WORK

Girobond NBS is a trailblazing bonding alloy for the crown and bridge technique. The specific composition of this CoCrMo alloy, with fine admixtures but no carbon content, provides optimum properties for outstanding results.



Girobond NBS metal framework with porcelain facing (Dental lab Müsle, Pforzheim/Germany)

Hardness HV10

Comparison of hardness between Girobond NBS and conventional non-percious bonding alloys

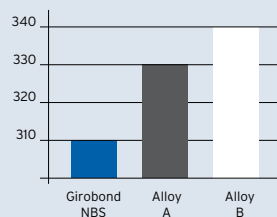

Comparison of the tensile bond strength of metals and ceramics

Requirement in accordance with ISO 9693

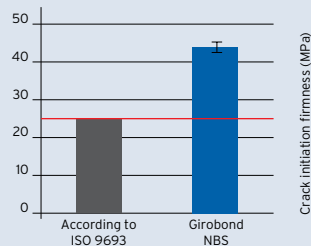

- _ CrMo bonding alloy for the crown and bridge technique, free of nickel and beryllium**
- _ Excellent laser welding behavior, no risk of crack development since carbon-free**
- _ Also suitable as universal alloy for model-casting clasp dentures, wide-span telescopic cases, and delicate suprastructures**
- _ High homogeneity within the batches and good reproducibility thanks to the optimized production process**
- _ Suitable for casting with any standard method**
- _ Good controllability of the melting and casting process**
- _ Easy milling (310 HV10)**
- _ Dense surface, good polishability, rich shine**
- _ Completely unproblematic and safe facing with conventional facing porcelains which suit the coefficient of thermal expansion of Girobond NBS $14.1 \times 10^{-6} K^{-1}$ (25-500°C)**

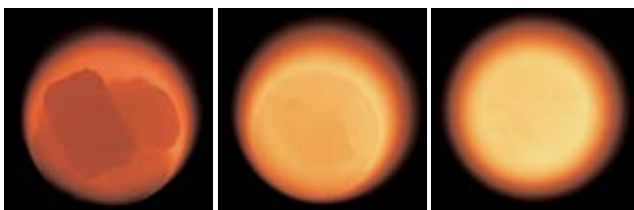

Melting behavior of Girobond NBS

Begin of the melting; the casting cubes melt into each other

The molten metal starts to burst; However, some shadows are still visible

The surface of the molten metal shines; The metal is completely molten - Casting has to be effected immediately

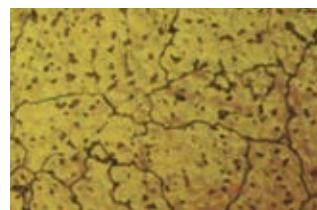

Fine-grained structure of the niobium-dispersed CoCrMo bonding alloy Girobond NBS (magnification 100:1)



Coarse-grained structure of a conventional CoCrMo bonding alloy (magnification 100:1)

MODERN NiCrMo BONDING ALLOY FOR CROWN AND BRIDGE WORK

Carbon-free, type 3 NiCrMo bonding alloy for crowns and bridges. Due to the dispersion with Niobium, GirobondCBS is easy to polish. Biocompatible thanks to the high Mo content. According certificates are available.

Comparison of the metal to porcelain compound

Requirement in accordance with ISO 9693

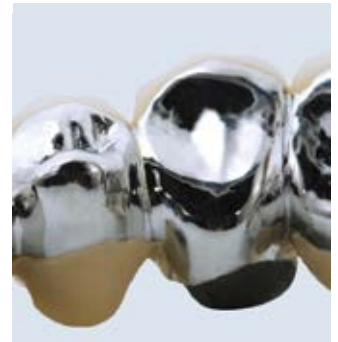
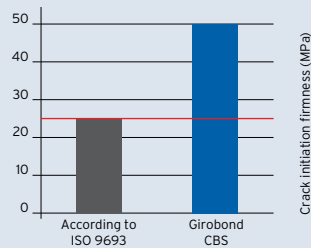

GirobondCBS metal framework with porcelain facing (Dental lab Müsle, Pforzheim/Germany)

CASTING

- _ Carbon-free NiCrMo-bonding alloy for crown and bridge works (type 3)**
- _ Good compatibility and reliability just like NBS, but softer (HV10 185) and thus easier to process**
- _ Safe, easily workable, cost-effective material**
- _ Optimised production process ensures high homogeneity**
- _ Easy to cast by any method**
- _ Carbon-free and thus no risk of crack formation; perfectly suitable for laser welding**
- _ Due to a TCE value of $13.8 \times 10^{-6} \text{ K}^{-1}$ (25-500°C), bonding of veneering ceramics is safe and trouble-free**
- _ Corrosion resistance has been proven by the Centre of Dentistry, Oral Medicine and Maxillofacial Surgery, University of Tübingen (Germany)**
- _ No overheating of the melt due to melt reflection**

Melting behavior of GirobondNBS/CBS



Begin of the melting; the casting cubes melt into each other

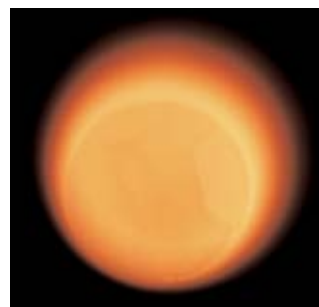

The molten metal starts to burst; However, some shadows are still visible

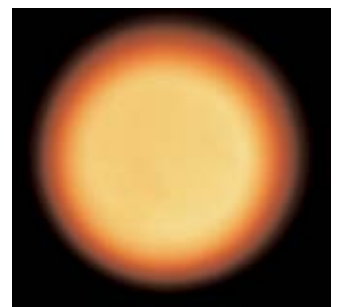

The surface of the molten metal shines; The metal is completely molten - Casting has to be effected immediately

THE IDEAL DENTURE BASE ALLOY FOR THE COMPLETE RANGE OF REMOVABLE DENTAL RESTORATIONS

Extra-hard, suitable for laser welding and easy to model - these are the requirements on a superior model casting alloy. With Girocrom FH, these requirements have become reality - a carbon-free alloy with excellent mechanical properties.

Laser welding offers dental technicians the advantages of modern joining technology and, at the same time, means maximum biological compatibility to the patient. Due to their carbon content, conventional alloys precipitate carbides during laser welding. These, in turn, have a quality-reducing effect on the welding seams and involve cracks and fractures.



Mandibular model casting denture with clasps, Dental Lab Müsle, Pforzheim/Germany



Girosolder out of CoCr, 3.6g as solder rods
Recommended for soldering of CoCrMo alloys

- _ Extra-hard denture base alloy**
- _ Improved stability**
- _ Suitable for all kinds of removable restorations, e.g. metal denture bases, combined fixed-removable restorations, telescopic cases, dentures with slide attachments or clasps**
- _ Easily activated clasps at model casting dentures, with minimized fracture risk**
- _ Carbon-free and, thus, ideal for laser welding**
- _ Easy processing and polishing; relatively low Vickers hardness HV10 of 350**
- _ Excellent biocompatibility and corrosion resistance**

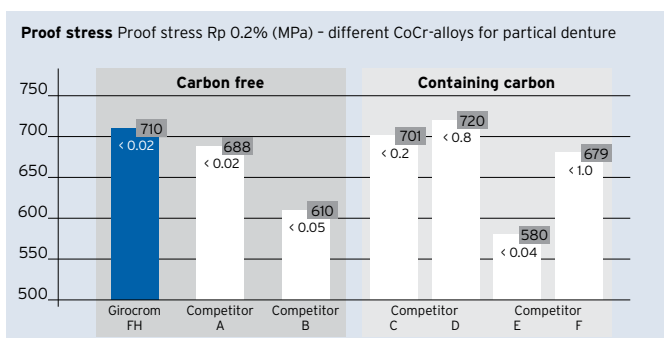

Cracks caused by carbide precipitation in a CoCrMo alloy containing carbon



Laser weld without any cracks in a carbon-free CoCrMo alloy

CASTING

THE IDEAL INVESTMENT FOR GIROCROM RESTORATIONS

Giroinvest Speed is a phosphate-bonded precision investment for the model casting technique.



- _ Phosphate-bonded precision investment for model casting**
- _ Can be heated up either with the shock-heat method or conventional heating with delay**
- _ 20 minutes setting time using the shock-heat method; the mold is subsequently placed into the preheated furnace heated up to a maximum temperature of 850°C; ready for casting after 60 min**
- _ Casting without casting ring possible**
- _ Smooth casing surfaces and excellent fit due to the shock-heat method**
- _ Expansion is regulated by adjusting the liquid concentration**
- _ The large 4 kg package size is based on the capacity of the Smartbox Invest and therefore makes storage easier**

A PRECISE AND CONTROLLABLE UNIVERSAL INVESTMENT WITH A WIDE SCOPE OF EXPANSION (1.2 TO 4.0 PERCENT BY VOLUME)

Unique: Giroinvest Super is an investment suitable for a wide range of applications. It can be used for crown and bridge works, high-gold-bearing, precious metal and non-precious metal alloys. Not only the work becomes noticeably easier and more efficient during the use of this investment; storage is considerably facilitated as well.

By changing the mixing ratio of water and liquid, the expansion range can be variably adjusted from 1.2 to 4.0 vol %. The precise adjustability in the lower and upper expansion area makes this investment perfectly suitable for press ceramics as well as non-precious metal alloys.



- _ For precious alloys
- _ For non-precious alloys
- _ For press ceramic
- _ For inlays, crowns, and bridges
- _ For conventional heating and shock-heat method
- _ Also suitable for ringless systems
- _ Extremely wide scope of expansion
- _ Neat and smooth casting surfaces
- _ Flexible and priceworthy use
- _ Reproducible casting results

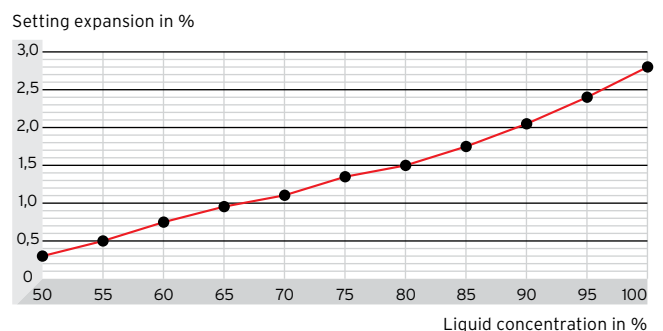

PRECISION MILLING UNIT FOR SURVEYING, BLOCKING OUT, MILLING

Stable precision milling device on solid vertical column with ball thread and playless, smooth, double-jointed arm. Milling head with micrometer screw for accurate adjustment of vertical drillings. Integrated control for micromotor, magnetic table with modular design and light connections. Micromotor can be replaced by optional analyzing rod for surveying or block out set for blocking out.



- _ Quick and easy fixing of the double-joint arm with one hand
- _ Automatic retraction of the articulated arm via memory function
- _ Model table can be magnetically fixed in its position automatically by pressing one button
- _ It is possible to fix the model table MT3 at the push of a button in any angle with the patented fixing mechanism
- _ Spring pressure arm resistance for vertical manoeuvrability
- _ Shadow-free illumination with the LED double light fixture
- _ Upgradable to an undercut and surveying machine (optional)

Blockout Upgrade Kit AF350 adjustable for blocking out and surveying

Delivery volume:

- _ Blockout set
- _ Marker
- _ Adapter cord, adjustable



Blockout set



Marker



Adapter cord, adjustable

The background features a series of overlapping, curved, grey shapes that create a sense of depth and movement. These shapes are layered, with some appearing in front of others, and they curve from the left side towards the right. The overall effect is a modern, minimalist aesthetic.

ORDER INFORMATION



Artex Typ CN



Artex Typ CT



Artex Typ CPR



Artex Typ CR



Artex Typ BN

Artex Articulators

217310	Artex Typ CN	
217320	Artex Typ CT	
218750	Artex Typ CPR	
218760	Artex Typ CR	
217360	Artex Typ BN	
218730	Artex Arcon clip	
217330	Modell plate blue (pair)	
217331	Modell plate blue	50 pcs.
215250	Retention Disks	100 pcs.
299991	Individual engraving on Artex	
217333	Support pin C screwable	



Dentist Kit

Free choosable Artex articulator, Splitex Plate Set, Artex Facebow, Splitex Transfer Stand

217310, 217320, 218750, 218760	Artex (CN, CT, CPR, CR)
216100C	Splitex Plate Set
218600	Artex Facebow
216240	Splitex Transfer Stand



Dentist Mini Kit

Artex Facebow, Splitex Transfer Stand

218600	Artex Facebow
216240	Splitex Transfer Stand



Technician Kit

Free choosable Artex articulator, Splitex Plate Set, Counter Plates, Retention Disk, Splitex Key

217310, 217320, 218750, 218760	Artex (CN, CT, CPR, CR)	
216100C	Splitex Plate Set	
216235	Counter Plates	100 pcs.
216150	Retention Disks	
216010C	Splitex key	





Splitex Keys

216010C	Splitex key for Artex, 126 mm, C-Version
216010	Splitex key for Artex, 116 mm
216011	Splitex Spacer Plate +10 mm (required for new serial 126mm)

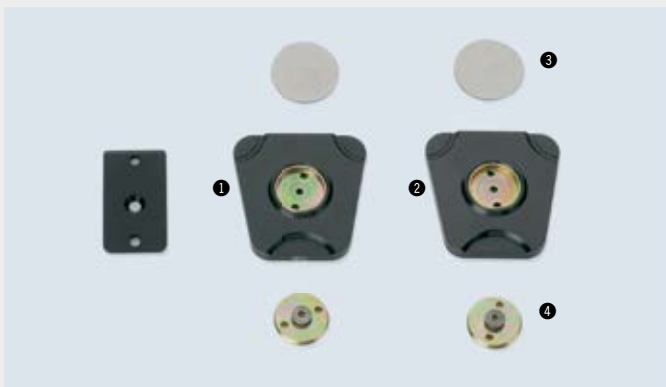

Splitex Disc Set

216100C	① - ⑥ Plate Set, C-Version	
216100	Plate Set (without picture)	
216110C	① Base Plate (TOP) without magnet	
216120C	② Adjust. Plate mandibular without magnet	
216150	③ 2 Retention Disks	100/pkg.
21611C	④ 2 mounting plates with screws	
216170	1 screw set max./mand.	2/pkg.
216140	Magnets	6 pcs.
216113C	⑤ Mounting tool for magnetic holder	



Splitex Counter Plate

The shock-resistant plastic material reliably adapts the Splitex plinth plate without distortion. Both plates are suitable for multiple use. The Premium quality (white) offers a higher accuracy (< 10 µm).

- _ Always available for quick, precise adaptation at the plinth plate
- _ Prevents the risk of ill fit since no plaster expansion takes place
- _ Tight, even model fixation, but nevertheless allowing safe removal and reposition

216230	Premium white	10/pkg.
216235	Classic black	100/pkg.
216150	Retention Disks, Ø 36.5 x 1.5 for Splitex	100/pkg.



Technical Data

Dimension: 160 x 160 x 160 mm
 Weight: 700g
 Finish: Aluminium anodize

Artex/Splitex Mounting Articulator

The mounting articulator is not used as an articulator, but can be understood as a device which protects this precision instrument. Since models can be freely exchanged between similarly-calibrated articulators, they do not need to be transported in the articulator but can be transferred using mounting articulators which are similarly calibrated to the same model settings.

- _Safeguards articulators against water and plaster dirt
- _Compatible with all types of facebow and transfer systems
- _Centric and vertical height are fixed using rigid hinge axis/incisal pins
- _Easy removal of the models due to a detachable magnet in the upper frame

216020	Splitex Mounting Articulator	
216020C	Splitex Mounting Articulator, 126 mm Carbon-Version	
216021	O-Ring for head support	
216030C	Anterior guidance pin 126 mm C-Version	

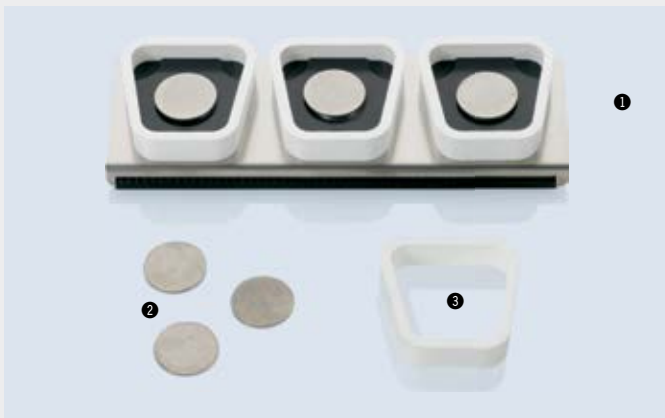

Splitex Master Platform Set (3 parts)

For the production of Splitex Counter plates made from surplus stone. Magnetically connects to the Splitex plates.

216200	1 Set, 3-parts	
216150	2 Retention Disk	100/pkg.
216220	3 Rubber frames for socket	3/pkg.
216141	1 Magnet (built-in)	



Splitex Mounting Glue

For the controlled fixing of the mandibular adjustment plate in the articulator. Creates the smallest gap width possible, no shrinkage, safe adhesion.

- _Economical, easy to use, and removable for renewed adjustment

513110	1 50 ml Mounting Glue / Loctite	
513120	2 150 ml Cleaner for Glued Areas	



Artex Separating Spray

Silicone-based separating spray for Metal, Stone, keeps Articulator and model plates clean.

743040	Artex Separating Spray	400ml
--------	------------------------	-------



Artex-Modell Plate

Artex model plates enable easy and quick retaining due to integrated magnets in the upper and lower part of the Articulator. Suited for multiple use.

217330	Modell plate blue (pair)	
217331	Modell plate blue (pair)	50/pkg.
215250	Retention Disks	100/pkg.





Dr. Behrend Type Clinometer

Adjustable Perspex® shield furnished with several vertical lines and two horizontal lines, for transferring physiognomic esthetic parameters. Once adjusted to the facebow, the horizontal lines can be aligned to match the eyes and the line of the anterior teeth, using the rotary control. The tooth position as determined is represented as an angle, and can be transferred to the articulator in the laboratory to recreate the position of the anterior teeth.

- _Determines asymmetries and compensates them during set-up
- _Supplies the technician with important esthetic information
- _Helps to prevent remakes, improves function and esthetics



- | | | |
|---------|---|-------------------------|
| 219960C | ➊ | "Operator" Clinometer |
| 219950 | ➋ | "Laboratory" Clinometer |
| 218110C | | Pin holder |
| 217131 | | Cranked pin for Artex |



Centrofix according to Dr. Lüth

Intra-oral centric registration with vertically adjustable tracing ball: Corrects the vertical distance during registration and locks the determined centric position without plaster by means of an adjustable clamp. German Patent 4014975, US Patent 5.188.529.

- _Time-tested support pin methodology - safe functional results
- _All relevant information in one session: moulding, jaw relation/ vertical distance, axial relation, aesthetics template
- _Stable and reliable registrations and information for your lab



- | | | |
|--------|-------|-------------------------------|
| 242700 | ➌ - ➍ | |
| 242710 | ➌ | Writing board broad |
| 242720 | ➍ | Writing board narrow |
| 242740 | ➎ | Pin carrier |
| 242750 | ➏ | Tracing ball long |
| 242751 | ➐ | Tracing ball short |
| 242760 | ➑ | Adjustable clamp |
| 242780 | ➒ | Cross |
| 242790 | ➓ | Combination wrench |
| 242810 | ➙ | Copper writing platelets |
| 242820 | ➚ | Spirit level |
| 242830 | ➛ | Distance piece (plastic hose) |

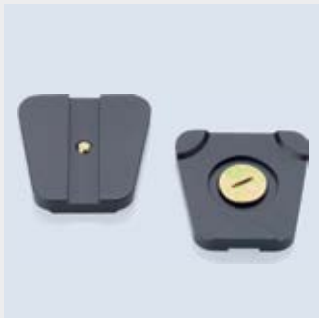

Artex Set-Up Index Key for the maxilla

This facilitates average-value alignment of the edentulous maxilla at the remaining anatomical fold in the throat. The vertical adjustment of the support fork and the reciprocal bar facilitate improved individual positioning of the model.

- _ Semi-individual positioning in the articulator without facebow
- _ Basic version with screw thread, or conversion plate for the Splitex System

216255C incl. thread (Thread version) for Carbon-Version



Artex Set-Up Index Key for the mandible

Fundamental scale for average-value alignment of the edentulous mandible model at the symphysis and retromolar pads.

217700 ❶ with thread

217700C ❷ 126 mm for Carbon-Version

216250C Setup index key with Splitex, 126 mm for Carbon-Version



Artex Set-Up Templates

Guide for set-up of full dentures according to the Spee/Wilson occlusion curve. The horizontally and vertically adjustable device with occlusal plane indicator and adjustable inclination supports the different templates.

- _ Flat template for average-value mounting of dentulous models
- _ 4 radius for adjustment to different tooth/set-up concepts
- _ Screw or magnet version, to be ordered separately or as a set

217730 Setup template, "thread"

217730C ❶ Template holder, thread for Carbon-Version

217740 Template flat

217741 Template R 100

217742 Template R 125

217744 Template R 140

217746 Template R 160

216260 Setup template with Splitex profile

216260C ❷ Template holder with Splitex, 126 mm for Carbon-Version

Ord.-No.	Spherical cap radius	Molar cusps	Tooth type	Tooth manufacturer
217746	160 mm	30-35°		
217744	140 mm	25-28°	Poly-Star Lux HK, Creapearl 2, Creopal, Biodent, Articron Orthognat	Creation, Merz Dental, De Trey, Lindauer Zähne, Ivoclar, Weithaas, VITA
217742	125 mm	15-16°	n, t, k, Odilux	
217741	100 mm	0°	Orthocal	Lindauer Zähne





Artex Anterior Guidance

Special accessory which fits in all Artex Articulators, to mechanically individualize/program the anterior area.

_Micrometer pin to exactly raise/lower the anterior guidance in steps of 1/10 mm

_Individual anterior guidance using radially guided pin with infinitely variable table plate (protrusion 0-40°, laterotrusion 0-70°, turning to right and left)

_Cranked pin provides for unhindered access during anterior set-up and maintains clear sightlines

217586	6	Support pin
217589	7	Anterior guidance pin
217589C		Anterior guidance pin, C-Version
217585	8	Anterior guidance pin complete
217585C	5	Anterior guidance pin for Carbon-Version
218170C	4	Individ. anterior guidance, 0-70° protrusion, 0-40° laterotrusion pin, table, adjusting bolt for Carbon-Version
218162	9	Heightener 10 mm for radial pin
218120C	15	Radial pin, C-Version
218135C	16	Radial pin insert, angled
217260	10	Artex Incisal needle
218140	11	Artex Incisal plate incl. 218141, 218142
218141	12	Table adapter 10°
218142	13	Table adapter 20°
217340	2	Plate anatomical for Carbon-Version (40° protrusiv; 30-40° laterotrusiv)
217342	1	Standard incisal plate 0° for Carbon-Version
218110C	15	Pin holder
217131	14	Micrometer pin
218180	3	Micrometer pin Artex

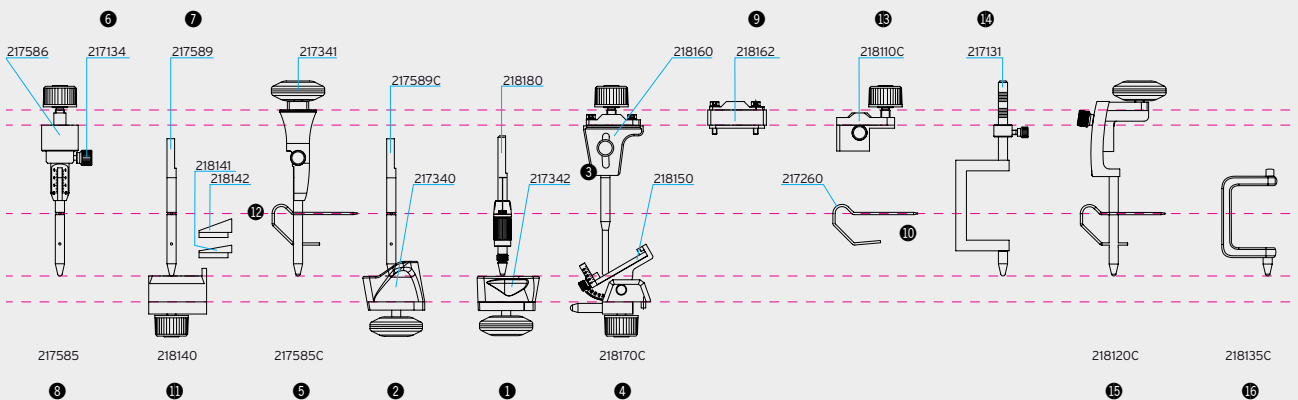

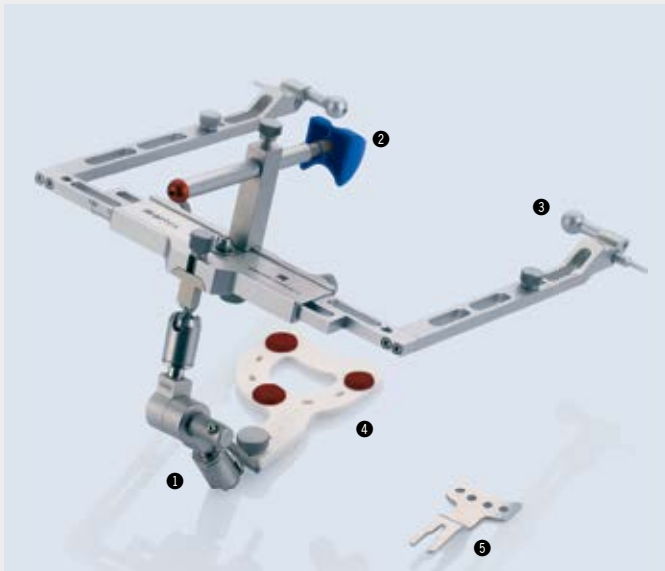

Artex Facebow C€

218600	① - ⑤	
218620	① Joint Support	
218680	② Leipzig Nasion	
218607	③ Porus Buttons "Standard", pair	
217650	④ Artex Quickbite	10/pkg.
217928	⑤ Tray Handle	

Optional accessory

218609	Porus Buttons long, pair	
218610	Axis-plane Pointer w. screw	
218635	Carrier for Facebow Cadiax compact, pair	
218690	Nasion vertically adjustable	
217650	④ Artex Quickbite	10/pkg.
217928	⑤ Tray Handle	5/pkg.
217611	⑥ Bite fork partial two-pack	2/pkg.
217695	Nasion adapter, blue (for cushioned Leipzig nasion)	



Bite Tabs C€

Thermoplastic pellets on self-adhesive foil to cover the metal bite fork for facebow registration.

642150	Bite Tabs, 180 Tabs
--------	---------------------



Artex Transfer Stand

For safe transport of the facebow registration to the lab. The universal joint with bite fork is removed from the facebow and inserted into the reception of the transfer stand. There, the registration is fixed in plaster. The detachable transfer table safely and unshakeably takes this important patient information to the lab.

218670C	① Transfer Stand with table for carbon version
216240	② Splitex Transfer Stand complete



Artex Transfer Table

The detachable part of the transfer stand, either with screw for model plates or furnished with Splitex magnetic plate. Several transfer tables are necessary in case of short registration intervals (whereas only one facebow and one transfer stand are required).

- _Saves money since only one facebow is sufficient
- _Saves plaster work at the practice but ensures safe transport to the lab

217671C	① Transfer Table for carbon version
216270	② Transfer Table with Splitex Profile



Artex Transfer Jig

Another direct alternative to the transfer stand and to the direct face-bow transfer. The universal joint with bite fork is attached to the jig holding the registration in axis relation while fixed at the bottom part of the artex articulator.

- _Direct and safe model transfer without additional steps
- _Reasonable solution at the practice - saves one "plaster cycle"

218631 Artex Transfer Jig



Artex Bite Fork Support/Telescoping Legs

Infinitely variable bite fork support (see picture above). The magnetic plinth is compatible with all conventional articulators.

- _Fits all types of articulators, either fixed with screw or magnetically
- _Height adjustment by means of a thread, fine adjustment by telescopes

The telescoping legs are screwed in to support the facebow anteriorly during the direct transfer of the facebow registration into the articulator. A level helps to adjust the facebow horizontally to the table plane.

217685 Bite Fork Support

217624 ① 2 Telescopic Legs ② + Level



Artex case

217991 Artex case with foam rubber padding (without content)



Artex iTero

The Artex iTero model adapter set enables direct transfer of a set of models created from iTero scan data to the Artex Carbon articulator.

216310 Artex iTero model adapter (set)



Technical Data
 Dimension: 67 x 35 x 46 mm
 Weight: 157 g



Artex Noplast

Artex Type NK for easy mechanical model fixation without plaster. The freely movable model plate safely holds the model in place according to the conventional method with a model table. With help of female thread screws, bars/joint discs rigidly block the relation, strain-free and distortion-free.

- _ Time-saving interim solution for model analysis/discussion
- _ For the making of individual trays/templates and for orthodontic apparatuses
- _ To check the function of Co-Cr cases on investment models
- _ Spares valuable working articulators if used for interim steps (but it may not, and cannot, replace the model plaster for definite restorations!)

217480C Noplast for Artex Carbon



Spray marker

Green occlusion spray with food-grade ingredients. Develops only little spray-dust, fully water-soluble.

- _ Homogenous spray pattern
- _ Allows for precise dosing
- _ High selectivity

541390 Spray marker green

75 ml



1
Technical Data
 Dimension: 120 x 90 x 110 mm
 Weight: 480g
 Finish: Alluminium anodized

Artigator

For the expert and artistic processing of the "triple-tray technique" by the dental technician. This way allows to directly transfer the impression into the position-safe auxiliary Artigator articulator, regardless of the cranium/axis relation.

- _ Sturdy unit with safe centric and Artex "click" lock
- _ Performs average-value movements as well as immediate sideshift (ISS)
- _ Full frontal access for proper adjustability thanks to the crank pin
- _ Direct segment model in magnetic pin plate
- _ Replaces four work steps with one, saves half the plaster consumption
- _ Quick amortization due to enormous time and material saving

218950 **1** Artigator incl. 2 Base Plates blue

Accessory

218941 **2** Artigator - Base plate blue 50 pcs.

218933 **3** Artigator base collar

218934 Artigator incisal pin

218931 **4** Artigator pin plates U (upper)

218932 **4** Artigator pin plates L (lower)





Technical Data
 Dimension: 250 x 183 x 370 mm
 Weight: 9.6 kg
 Mains supply: 230(100/115)V/0.32W
 Motor speed: 2,800 min⁻¹
 Laser class: 3A < 5mW

Giroform pin drill

176701 Giroform pin drill
Delivery volume: Tungsten carbide burr 176710, Universal plate holder 176713, impression carrier 176733, Tubular socket wrench 176702, holding pin 176703, screw driver for adjustment 176004

176710	Giroform-Tungsten Carbide Burr
176713	Universal plate holder
176733	Giroform-Impression carrier



Giroform Starter Kit

576702	Giroform Starter Kit	
176710	1 Tungsten carbide burr	
176733	2 Impression Carrier 2x	
321070	3 NT-Cutter	
359010	4 Hammer with Aluminium handle	
576450	5 Giroform-Pins	1,000/pkg.
576461	6 Giroform putty Putty	1kg
576710	7 Giroform base plate Premium +	100/pkg.
5767501	8 Giroform secondary plate XL with magnet	5/pkg.
576765	9 Adjustment plate clear	2/pkg.
576950	10 Giroform sleeve "kombi"	
576805	11 Giroform space retainer foil	50/pkg.
815300	12 Arbor band mandrel	2.35 mm
815330	13 Arbor band, grain 120	50/pkg.
990252	14 Timer	



Giroform Base Plates, 100/pkg.

576710	1 Premium+ L (incl. metal disc)	
576745	Premium+ XL (incl. metal disc)	
576747	Premium+ L blue (incl. metal disc)	
576720	2 Classic L	
576740	Classic XL	
576726	3 Classic L blue	
576765	4 Adjustment plate L	2/pkg.
576766	Adjustment plate XL	2/pkg.



Giroform Secondary Plate

576750	L with magnet	50/pkg.
576751	XL with magnet	50/pkg.



Giroform Pins

576450	Giroform Pins	1,000/pkg.
576451	Giroform Pins	10,000/pkg.



Giroform Quadrant Base Plate

Shape retaining acrylic base plate for Quadrant impressions.

576770	Giroform Quadrant base plate	100 pcs.
576771	Giroform adjustment plate for Quadrant	2 pcs.



Giroform Adapter for Vertex®

Adapter for usage in the Giroform base mounting plates in Vertex® single-use articulators.

576790	Giroform adapter for Vertex® articulators	100 pcs.
--------	-------------------------------------------	----------

Vertex® is a registered trademark of Dentsply Ceramco



Giroform pin drill

Conical hard metal drill, cutting geometry perfectly matches the Giroform base plate material.

_Short chips smooth cladding

176710	Giroform pin drill	
--------	--------------------	--



Giroform Putty

Silicone putty for placing and blocking the mould on the mould carrier, saves plaster as well as subsequent trimming and grinding, pleasant lemon fragrance.

_Great time-savings as a result of quick blocking

_Multifunctional

576461	Tub	1 kg
576465	Bucket	5 kg



Giroform Magnets and Sockets

Magnet Ø 31.9 x 6 mm, including socket and retention disc. Allowing removal of the model and reposition in the articulator. Independent system use.

512511	Magnetic plates Ø 20 x 6 mm	100/pkg.
512512	Sockets Ø 25 x 7.5 mm	100/pkg.





Giroform magnetic discs

- ❶ Edged, Ø 31.9 x 1.5 mm for universal usage,
- ❷ Stainless steel flat, edged Ø 36.5 x 1.5 mm for Splitex counter plates
- ❸ Ø 25 x 1.0 centric bore and M3-countersunk screw for Giroform Classic base plates

215660	❶ Retention discs cranked Ø 31.9 x 1.5	100/pkg.
216150	❷ Retention discs stainless steel Ø 36.5 x 1.5 for Splitex	100/pkg.
576716	❸ M3-Retention discs for Giroform Classic Ø 25 x 1.0 incl. screws	100/pkg.



Giroform Space retainer foil

Provides enough space for pins and magnet. Stabilizes the base plate in the area of the splitcast profile.

576805	Giroform Space retainer foil	50/pkg.
--------	------------------------------	---------

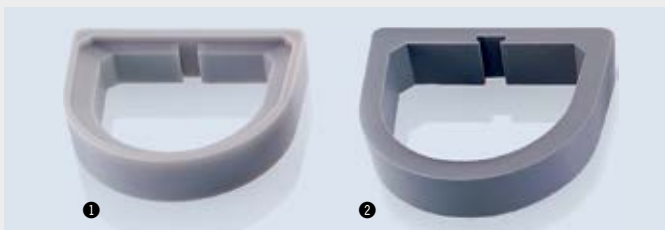

Giroform Base Collar

Used Giroform Base Plates which have already been drilled can be used to make master casts.

576950	❶ Base Collar L-Kombi	
576961	❷ Base Collar XL	



Giroform Duplication Flask

For the duplication of refractory dies varying in size from single segments up to the complete dental arch. Suitable for Giroform base plate L.

576670	Giroform Duplication Flask	
--------	----------------------------	--



Giroform Refractory Pin

Removable conical ceramic pins, inserted into the base plate, are used in refractory duplication.

576480	Giroform Refractory Pin	25/pkg.
--------	-------------------------	---------



Giroform Labels

909032	Giroform Labels	1,000/pkg.
--------	-----------------	------------



Noflame Plus

116250 Noflame Plus

Delivery volume: basic unit with power cable, 2 protective covers

116210 Protective caps

10/pkg.

Technical Data

Dimension: 195 x 85 x 83 mm

Weight: 600g

Mains supply: 230V/50Hz/130W



Smartwax Duo

116270 Smartwax Duo, basic unit

Delivery volume: control unit with mains adaptor, handpiece with cord (116280), probe small incl. handle (116281), cotton role holder

116280 Handpiece with cord

Technical Data

Dimension: 130 x 150 x 50 mm

Cable length of handpiece: 1.8 m

Electrical specifications of mains adaptor: 110 - 230V 50/60 Hz

Output: 6 V, Power: 12 W

Temperature range: 50 - 220°C / 122 - 428°F - switchable

Accessories:

116281 ① Probe small incl. handle

116282 ② Probe large incl. handle

116283 ③ Needle incl. handle

116284 ④ Beaver tail incl. handle

116285 ⑤ Knife incl. handle

116286 ⑥ Spoon incl. handle



Waxjet (pat. pend. ZTM Jonas)

Intelligent solution for application of wax. The continuous wax supply via the unique feeding mechanism of the Waxjet allows the dental technician to quickly apply a big amount of wax. The fluidized wax gets through the concave probe to the tip and the quantity of the wax can be determined individually by the technician - depending on, how quickly the wax wire is put forward with the help of the driving pulley.

_ Twice the speed of wax up work = 50% saving of time

_ No annoying wax taking up

_ For quick superficial fusing and application of wax

116287 Waxjet incl. handle

641060 Waxjet wire pink / 6.0 / 280g

The Waxjet in action - e.g. during filling of the gingivobuccal fold. Rapidly ready for use - one touch is enough





Technical Data

Dimension: 335 x 240 x 590 mm
 Weight: 16.5kg
 Mains supply:
 100/115/230 V, 50/60Hz
 Machine rating: 95W
 Capacity powder: approx. 8kg
 Time to allot 20 ml : 100g approx. 30s

Smartbox X2

116170 Smartbox X2
 230 V (115 V = 116170V115)

Delivery volume: Basic unit with integrated 8kg plaster container, 3l water container, power cable

116101 Protection cover

117201 Beaker distance piece 2 pcs.



Technical Data

Dimension: 250 x 160 x 350 mm
 (without stand)
 Weight machine: 8.5kg
 Weight stand: 7.9kg
 Mains supply: 100/115/230 V, 50/60Hz
 Machine rating: 210W
 Delivery rate: 15.8l/min
 Vacuum power: -800mbar

Smartmix X2

115700 Smartmix X2 wall mounting 230 V

Delivery volume: basic unit with beaker 500ml, for wall-mounting, drilling template, 4 screws with dowels, 1 replacement filter

115730 Stand for Smartmix X2

115620 Beaker with mixing blade 100ml

115630 Beaker with mixing blade 250ml

115640 Beaker with mixing blade 500ml

115650 Beaker with mixing blade 750ml

115660 Beaker with mixing blade 1000ml

115621 Beaker 100ml

115631 Beaker 250ml

115641 Beaker 500ml

115651 Beaker 750ml

115661 Beaker 1000ml

115701 Spare filter for Smartmix X2 5/pkg.



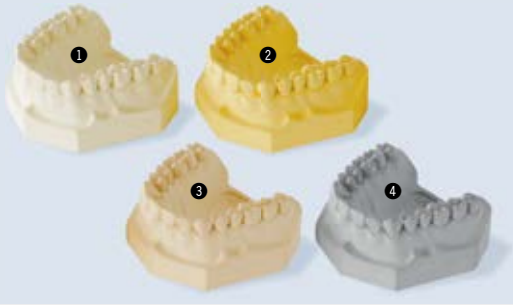

Alpenrock

Classical super hard Class 4 gypsum for the production of tooth arches, single stumps and control models. The expansion is ideally matched to Giroform model creation. The expansion is ideally matched to Giroform model fabrication.

711110	③ gold	20 kg carton (5 x 4 kg bag)
711120	① pastel	20 kg carton (5 x 4 kg bag)
711130	② saffron	20 kg carton (5 x 4 kg bag)
711140	④ grey	20 kg carton (5 x 4 kg bag)



Girocko

Girocko is a synthetic, Class 4 high-strength dental stone - also ideal for fabricating models using Giroform.

711160	gold	20 kg carton (5 x 4 kg bag)
711170	grey	20 kg carton (5 x 4 kg bag)



Girostone

Synthetic class 4 super-hard plaster, universal for all prosthetic applications, material of choice for situation and master models - also for fully prosthetic working models due to its low brittleness.

_ Cost-efficient high-quality super-hard plaster in 3 colours

711021	rosé	20 kg carton
711022	pastell	20 kg carton
711023	yellow	20 kg carton



Girodur

Synthetic class 4 super-hard plaster for stump and master models.

_ Low-price alternative to all precision model types

711105	white	20 kg carton
--------	-------	--------------



Giroplast

High-strength synthetic plaster for full prostheses, especially for plastic extrusion techniques (e.g. polyan). The great working pressure during insertion of the plastic material into the container requires high pressure-resistance to counteract deformation.

_ High strength for plastic extrusion

_ Expansion values adjusted to full prostheses

711050	blue	20 kg carton
--------	------	--------------



Artifix

White synthetic articulation plaster with minimum expansion, suitable for manual and machine mixing. Indication: working models articulating, orthodontic models rebasing, fixation of milling bases, bite registration and indexes.

711217	Artifix	20 kg carton
--------	---------	--------------





Abrasive belt / mandral

For pre-trimming of model stumps and trimming of tooth arches.

_ Quick, efficient and vibration-free removal of material

815300	Mandral cylindrical	
815310	Grain 80, ISO 070, length 11mm	50/pkg.
815330	Grain 120, ISO 070, length 11mm	50/pkg.
815340	Grain 240, ISO 070, length 11mm	50/pkg.



Model boxes

Deep-drawn transparent box for transporting dental models, self-locking, with 2 foam rubber cushions.

_ Various sizes and heights, also for plastic bases

_ Cost-efficient bulk packaging of 30 pieces each (10x3 units)

511430	small	78 x 70 x 45 mm
511450	large	90 x 80 x 60 mm
511460	x-high	90 x 80 x 80 mm



Girosolve Pro

Plaster dissolution with high dissolving speed and capacity, for all kinds of plasters and plaster-bonded investments. Dissolves and removes plaster remainders from dentures, impression trays, mixing bowls, and cast objects.

_ Higher effectiveness and economy - increased by 20 %, control through bubble activity

_ No acids, neutral pH-value, suitable for all materials

_ Efficiency multiplies if used in an ultrasonic bath

_ Disposal of used solution through the sewage system

714050	Girosolve Pro	2 l
--------	---------------	-----



Technical Data

Dimensions: 406 x 280 x 423 mm
 Weight: 16 kg
 Electrical connection values (V/A/Hz):
 230/3.6/50-60, 115/7.0/50
 Performance: 1000 W
 Volume: max. 52 dbA
 Filter bag size: 10l
 Hose diameter: 38 mm
 Hose length: 1.8 m
 Adapter diameter: conical, 37-38 mm
 HEPA micro filter (97.97%),
 Filter class H12, dust class M

Ceramill Airstream

_ Extractor for Ceramill Motion

_ May also be used for other devices with attached adapter

178600	Ceramill Airstream 230 V (100-120V = 178600V100-V120)	
178610	Airstream Suction Bag	5 pcs.
178611	Airstream Microfilter	1 pc.



Steamer X3

116910 Steamer X3 230 V

Delivery volume: Mounting template, Instruction for use, Test strips for measuring water hardness, 1 x 250 ml bottle of Kalk-X descaling liquid Power cord, Set of safety cap gaskets (white teflon gasket and silicone gasket)

Accessory

116811	Kalk-X Liquid descaling agent	4 x 250 ml
516330	Clean Steamer	
516340	StymoNet	
116911	Sealing lid	
116912	Seal for lid	

Technical Data

Dimension: 275 x 265 x 455 mm
 Weight: 12.5 kg
 Mains supply: 230V/50 Hz /115V/60 Hz
 Machine rating: 1600W / 1000W
 E-fuse: T10A
 Boiler volume: 3.7l
 Vapor pressure: 4.0 bar
 Warm-up time: approx. 25min



CleanSteamer

Hollow cylinder with hinged lid and sieve portion to collect impure small parts (teeth, crowns, etc.). By opening the hinged lid, saturated steam is blown into the object carrier. Addition of dishwashing liquids possible.

516330	CleanSteamer
516338	Steamer X3-adapter

Spare parts

516332	Lid handle insulation
516333	Steam inlet insulation
516334	Hinged lid insulation



StymoNet

Self-locking tweezers with fine-mesh stainless plastic net to fix delicate objects such as ceramic teeth; inlays etc. during cleaning with saturated steam.

516340	StymoNet
--------	----------



Ceramill Sep - Thinner and more reliable coating, lemon-scented

Ceramill Sep

Isolates the modelling resins Ceramill Gel/Pontic from gypsum and stump varnish (especially Giroform Die Link).

760561	Ceramill Sep
--------	--------------



1



2

Ceramill Gel/Pontic

Light-hardening modelling synthetics for crowns and intermediate bridge elements.

760514	1 Ceramill Gel - light-hardening synthetic modelling material for crowns, green, 3g	4/pkg.
760522	2 Ceramill Pontic - light-hardening synthetic modelling material for intermediate bridge elements, blue, 3g	2/pkg.



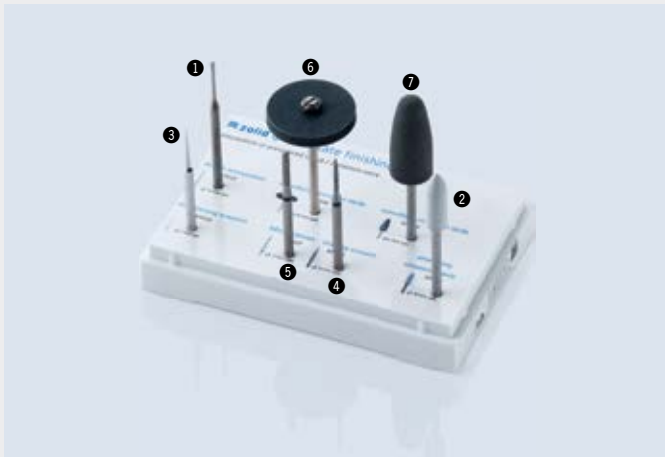

Zolid Green-State Finishing Kit

Rotary instruments for dental technicians for preparing sintering metal or zirconia in the pre-sintered state

875520 Zolid Green-State Finishing Kit		
Pack contents: see image		
875521	❶ Separating cutter for removing from the blank	
875523	❷ Universal polisher for smoothing the surface	5 pcs.
875524	❸ Fissure cutter squared for creating fissures	2 pcs.
875526	❹ Diamond flame for reworking fissures	5 pcs.
875527	❺ Diamond parallel for creating labial texture	5 pcs.
875528	❻ Polishing disc without mandrel for thinning out the crown margin	10 pcs.
875529	❼ Polishing grenade for grinding connectors	5 pcs.

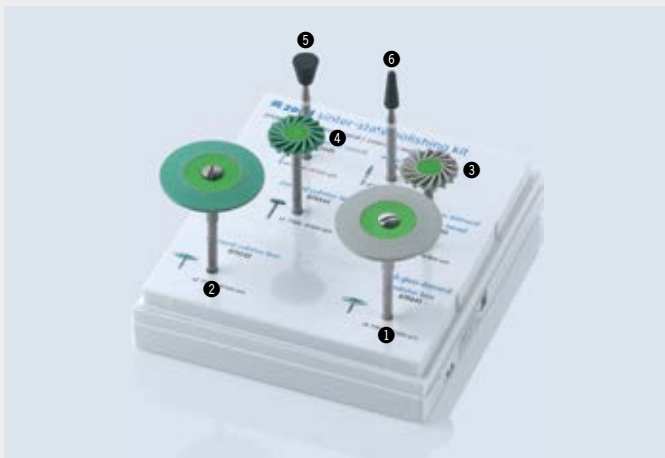

Zolid Sinter-State Polishing Kit - Lab Kit

Zircon oxide-polishing set for the dental technician

875540 Zolid Sinter-State Polishing Kit - Lab Kit		
Delivery includes: see image		
875541	❶ High gloss diamond polisher, lens	
875542	❷ Diamond polisher, lens	
875543	❸ High gloss diamond polisher, lab swivel	2 pcs.
875544	❹ Diamond polisher lab swivel	2 pcs.
875545	❺ Abrasive inverted conical	2 pcs.
875546	❻ Abrasive conical	2 pcs.

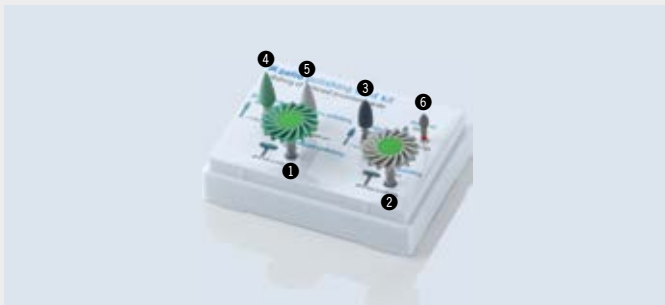

Zolid Polishing Dent-Kit

Zircon oxide-polishing set for the dentist

875550 Zolid Polishing Dent-Kit		
Delivery include: see image		
875551	❶ Smoothing and pre-polishing, swivel	2 pcs.
875552	❷ High gloss polishing, swivel	2 pcs.
875553	❸ Abrasive	2 pcs.
875554	❹ Gloss polishing, flame	2 pcs.
875555	❺ High gloss polishing, flame	2 pcs.
875556	❻ Diamond	



All-Bright Diamond Paste

polishing paste

761938	All-Bright Diamond Paste 11g	1 pcs.
--------	------------------------------	--------



Zirconia Stain Pinsel

Brush for applying the Zolid liquids

761939	Zirconia Stain 3 in 1 Brush Kit	1 pcs.
--------	---------------------------------	--------

Delivery volume: Zirconia Stain Brush Size 1 (1 pcs.), Zirconia Stain Brush Size 2 (1 pcs.), Zirconia Stain Brush Size 3 (1 pcs.)



Optimum Brush Line

Brush with lightweight, ergonomic aluminum handle with innovative spring activation system in the brush tip for the perfect design

761895	Optimum Spring Master Kit Size 6	1 pcs.
--------	----------------------------------	--------

Delivery volume: 761897 Optimum Spring Ceramic Brush Size 6 (1 pcs.), 761899 Optimum Ceramic Brush Stain (1 pcs.), 761900 Optimum Ceramic Brush Opaque (1 pcs.), 761901 Optimum Ceramic Brush Contour (1 pcs.)

761896	Optimum Spring Ceramic Brush Size 4	1 pcs.
761897	Optimum Spring Ceramic Brush Size 6	1 pcs.
761898	Optimum Spring Ceramic Brush Size 8	1 pcs.
761899	Optimum Ceramic Brush Stain	1 pcs.
761900	Optimum Ceramic Brush Opaque	1 pcs.
761901	Optimum Ceramic Brush Contour	1 pcs.
761902	Optimum Replacement Brush Tip Size 4	1 pcs.
761903	Optimum Replacement Brush Tip Size 6	1 pcs.
761904	Optimum Replacement Brush Tip Size 8	1 pcs.
761905	Optimum Replacement Brush Tip Contour	1 pcs.
761906	Optimum Replacement Brush Tip Stain	1 pcs.
761907	Optimum Replacement Brush Tip Opaque	1 pcs.



Revolution Brush Line

Brush with lightweight, ergonomic aluminum handle

761911	Revolution Master Kit Size 6	1 pcs.
--------	------------------------------	--------

Delivery volume: 761913 Revolution Ceramic Brush Size 6 (1 pcs.), 761915 Revolution Ceramic Brush Stain (1 pcs.), 761916 Revolution Ceramic Brush Glaze (1 pcs.), 761917 Revolution Ceramic Brush Contour (1 pcs.)

761912	Revolution Ceramic Brush Size 4	1 pcs.
761913	Revolution Ceramic Brush Size 6	1 pcs.
761914	Revolution Ceramic Brush Size 8	1 pcs.
761915	Revolution Ceramic Brush Stain	1 pcs.
761916	Revolution Ceramic Brush Glaze	1 pcs.
761917	Revolution Ceramic Brush Contour	1 pcs.
761918	Revolution Replacement Brush Tip Size 4	1 pcs.
761919	Revolution Replacement Brush Tip Size 6	1 pcs.
761920	Revolution Replacement Brush Tip Size 8	1 pcs.
761921	Revolution Replacement Brush Tip Contour	1 pcs.
761922	Revolution Replacement Brush Tip Stain	1 pcs.
761923	Revolution Replacement Brush Tip Glaze	1 pcs.





Instrument Bench Stand

For storing brushes

761930	Instrument Bench Stand	1 pcs.
--------	------------------------	--------



CAD Artistry Mixing Palette

Palette for mixing ceramic materials

761927	CAD Artistry Mixing Palette	1 pcs.
761935	Nylon Sheet for CAD Artistry Palette	1 pcs.
761940	Absorbent Strips CAD Artistry Palette	2 pcs.



Peg Fix

Firing paste made of PCW fibers is suitable for firing ceramic and metallic restorations

761928	Peg Fix 9cc Box	3 pcs.
--------	-----------------	--------



Texture Eyes

Copper paste for the visualization of morphology and surface texture

761929	Texture Eyes 10 ml	3 pcs.
--------	--------------------	--------



Crown Holder Complete Kit

Products for safe processing of zirconium dioxide

761931	Crown Holder Complete Kit	1 pcs.
761932	White Gum Material	1 pcs.
761941	Black Gum Material	1 pcs.



Firing trays and ceramic pins

Products for safe processing during the firing process

761934	Honeycomb Stand incl. 10 Ceramic Pins	1 pcs.
761936	Ceramic Pins	10 pcs.
761937	Alumina Pins (ideal for implant work, due to special shape)	4 pcs.



Giroinvest Speed

Phosphate-bonded precision investment for model-casting.

724070 Giroinvest Speed Powder 5 x 4kg bag = 20 kg

724072 Giroinvest Speed Powder 100 x 200g bag = 20kg

724081 Giroinvest Liquid 1 l



Giroinvest Super

Phosphate-bonded precision investment for crown, bridge and inlay work and pressable porcelain.

781670 Giroinvest Super Powder 40 x 150g-bag = 6 kg

781680 Giroinvest Super Powder 50 x 100g-bag = 5 kg

781685 Giroinvest Super, 2 x 4 kg

724090 Giroinvest Super Liquid 1l





Girobond NBS

Packaging:

781610 Girobond NBS 1,000g



Girobond CBS

781690 Girobond CBS 1,000g



Girosolder

Dental solder for cobalt-based alloys

781630 Giro solder, 3.6g Lot in bars



Girocrom FH

721250 Girocrom FH 1,000g



Technical Data

Dimension: 340 x 250 x 450 mm
 Weight: 15 kg
 Mains supply: 100/115/230 V, 50/60Hz
 Motor speed: 1,000-40,000 min⁻¹
 Torque: max. 7.5Ncm

Milling Device AF350

177605 Milling Device AF350
Delivery volume: basic unit with vertical lift, milling arm with W&H motor spindle, model table MT3, twin LED lamp, cover

Optional accessory

- 177998 Blockout-Upgrade-Kit AF350, adjustable, 3 parts (for current version - see image)
- Delivery volume:** Blockout-Set 177990, Marking stick 17800, Adapter sleeve AF350 adjustable 177994
- 177995 Blockout Upgrade-Kit AF350, 4 parts (for previous version)
- Delivery volume:** Blockout-Set 177990, Adapter cord 177993, Marker 177800, Adapter cord for Marker AF350 177806
- 177800 Marker
- 177661 W&H Collet 3 mm
- 177661 W&H Collet 2.35 mm



Blockout

Heatable blockout blades 0° to 6°, with parallelly guided plug-in contact for handpiece connection. To be inserted into the chuck of the marker (Ø 3 mm). Connection to any controllable voltage source providing 24 V.

177990 Blockout and 5 inserts 0°-6°

Optional accessory

- 177991 Adapter cord AP100/Diacut/Blockout
- 177806 Adapter for marker AF350
- 177980 Blockout insert 0° Ø 1.3 mm
- 177981 Blockout insert 0° Ø 2 mm
- 177982 Blockout insert 2° conic
- 177983 Blockout insert 4° conic
- 177960 Blockout-set AP100 including adapter cord AP100



Model Table MT2/MT3/ Splitex

MT2: Inclination table, from 0° to 90°, both final positions are under forced guidance, fixed with manual clamp lever. Plinth plate may be magnetized.

MT3: Inclination 0° to 41°, manual/electromagnetic fixation by degrees, 0/2/4/6° also mechanical (sleeve/ring); electromagnetic positioning.

- 177350 ② MT3 / 0°-14°
- 177360 ① MT2 / 0°-90°



The background features a series of overlapping, curved bands in various shades of grey, creating a sense of depth and movement. The bands are positioned on the left side of the page, with the outermost band being the lightest and the innermost being the darkest. The text 'AG SERVICES' is centered within a white rectangular box on the right side of the page.

AG SERVICES



PREMIUM SERVICE - BEFORE, DURING AND AFTER SALES

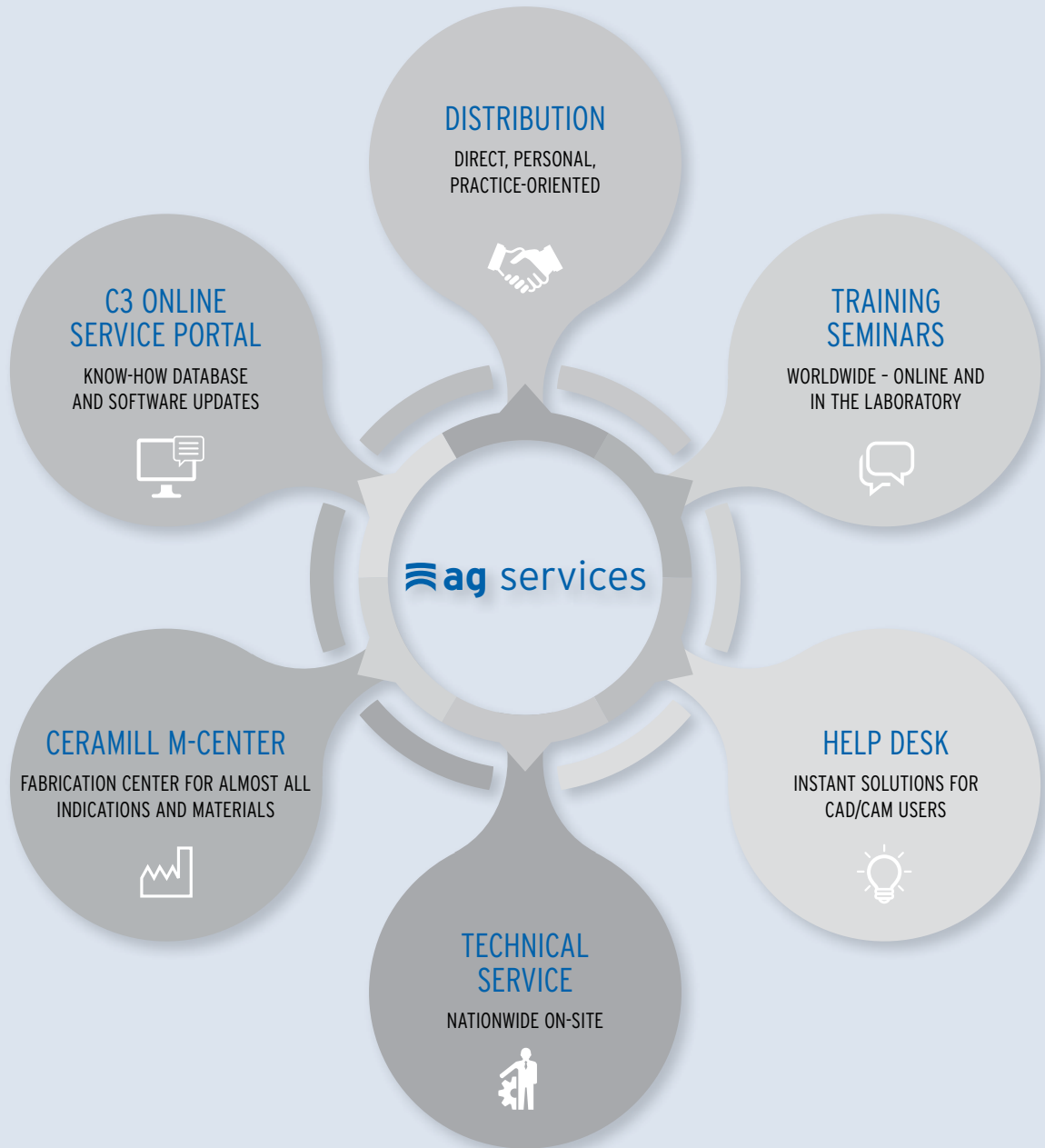

WE ARE CLOSE TO YOU.





-  **Headquarters**
- Production**
- Distribution**
- Training center**
- Helpdesk**

 **Exhibitions & Events**

Amann Girrbach AG

-  **Austria, Koblach | Headquarters**
 - > Research & Development
 - > Production
 - > Marketing & Distribution International
 - > International Training Center

-  **Austria, Rankweil | Dentistry One**
 - > Mechanical engineering
 - > Sintron and zirconia production

-  **Germany, Pforzheim**
 - > Storage | logistics | technical service
 - > Training Center for AT & DE
 - > Helpdesk worldwide

-  **Libanon, Beirut**
 - > Training Center Middle East
 - > Helpdesk Middle East

-  **Singapur (since 2011)**
 - > Sales office
 - > Training Center Asia
 - > Helpdesk Asia

-  **China, Peking (since 2013)**
 - > Sales office
 - > Storage
 - > Training Center
 - > Helpdesk



04



06



12



07



05



07

Japan, Tokyo

- > Sales office



07

USA, Charlotte, NC (since 2007)

- > Service Department
- > Training Center North America
- > Helpdesk America



08

Brazil, Curitiba (since 2013)

- > Sales office
- > Storage
- > Training Center



Exhibitions & Events

09

USA, Chicago, IL

- > Midwinter Meeting
- > APS (Prosthodontist Show)
- > LMT Lab Day Chicago



10

Brazil, São Paulo

- > CIOSP Congresso Internacional de Odontologia de São Paulo



11

Germany, Cologne

- > IDS - International Dental Show



12

China, Shanghai

- > DenTech - Exhibition



All exhibitions and congresses with current information:



AG TRAINING CENTERS - WORLDWIDE

Professional learning in a pleasant atmosphere - this is provided by the worldwide training centres of Amann Girrbach. You can get to know the world of our products and their application in all Amann Girrbach locations and with selected dealers and universities.



Götzis | Austria



Pforzheim | Germany



Charlotte, NC | USA



Singapore | Singapore

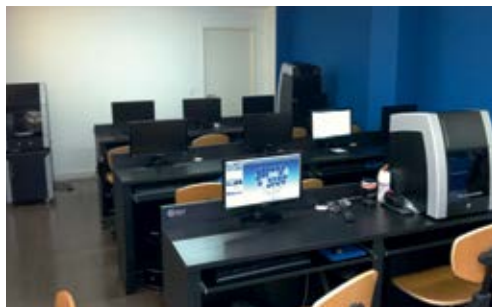

Curitiba | Brazil



Łódź | Poland



Beirut | Lebanon



Beijing | China

SYSTEMATIC TRAINING

Training in the accustomed Amann Girrbach quality, selected speakers, a wide range of nationwide courses and special in-depth courses. Through a modular training concept that includes both classic face-to-face courses and digital elements, your knowledge will be expanded step by step.

We are also prepared for individual requests. Contact us for an individual (online) training with one of our speakers.

Regardless of whether you are a beginner or an "old hand", the Amann Girrbach training program offers a wide range and the right course opportunity for every situation:

- _Course at the training center
- _Online training
- _Course in the laboratory/in the practice
- _Further training at events

We would be pleased to advise you on the right choice of your course. You can also book directly online and see immediately whether the desired course still has places available.

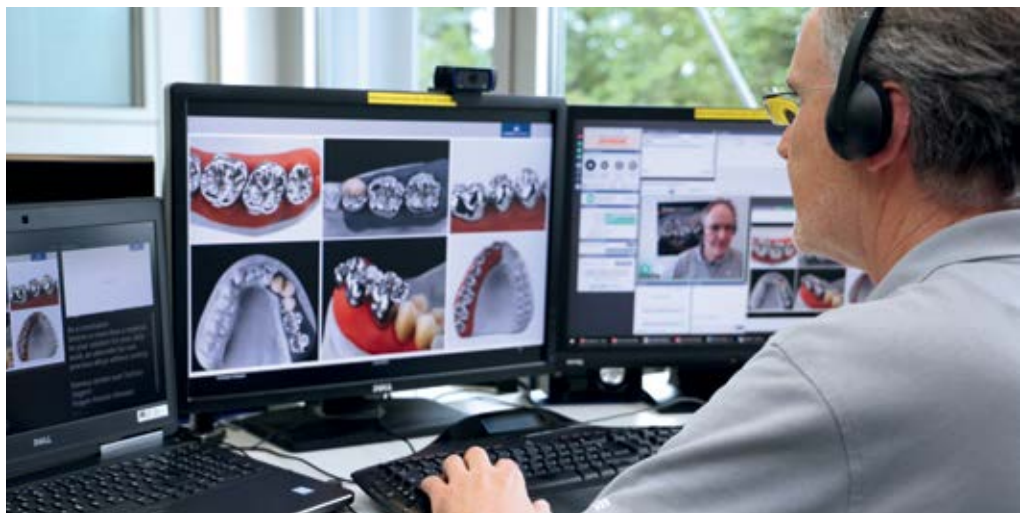

CONTACT

+49 7231 957-224
trainings@amangirrbach.com
**[www.amangirrbach.com/en/
services/training/dates](http://www.amangirrbach.com/en/services/training/dates)**

C3 - CERAMILL CUSTOMER CENTER YOUR SERVICE PORTAL ALL ABOUT THE CERAMILL SYSTEM

The Ceramill Customer Center is an online service portal and facilitates permanent smooth operation of our products and systems in a straightforward, self-explanatory and clearly structured manner.

With your login, you have access to all relevant information, current software updates and comprehensive service functions of your Amann Girrbach products.

C3 is developed in a technically completely new software environment. In future, this environment will offer new value-added functions for registration, activation, updates and support for daily laboratory routine.

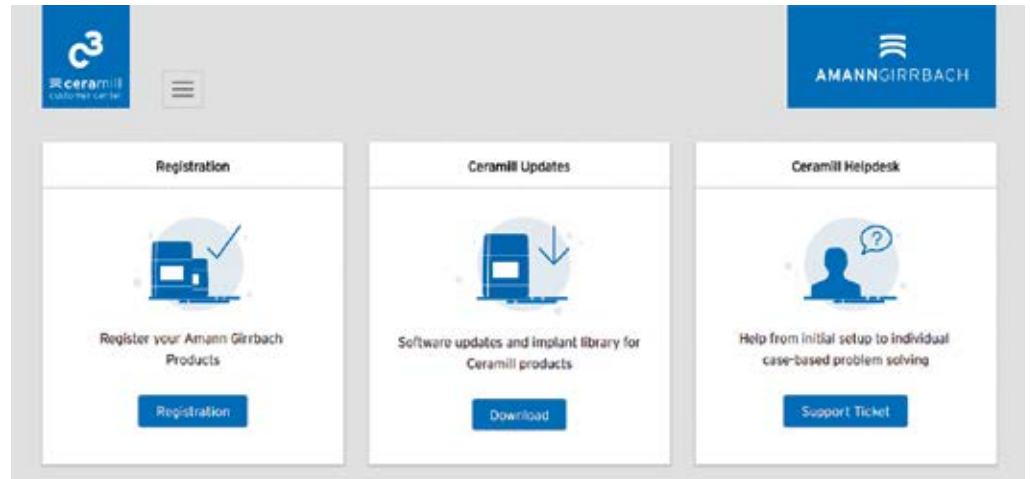

In the C3 Service Portal you will also find a valuable know-how pool that is available to you around the clock and which is always up-to-date. Print or video instructions for software and hardware are available here as are technical articles and studies.



- _ Amann Girrbach product registration/activation**
- _ Software updates (a prerequisite is a stable Internet connection)**
- _ Quick and easy access to the support form and thus competent help from the support center (Ceramill Helpdesk)**
- _ Know-how database - from videos to manuals**
- _ M-Center order processing (fabrication center) and overview of all M-Center orders**

CERAMILL HELPDESK. TARGETED AND SUCCESSFUL HELP FOR CAD/CAM USERS

The Ceramill Helpdesk provides information and help from installation to case-related problem solutions. A highly qualified international team of dental technicians are at the ready with a high degree of expert knowledge and competence in solving problems.

By using the telephone or desktop sharing via the Internet, we are directly in your laboratory and thus offer a high instant solution rate that makes you productive quickly.

Ceramill customers receive full support via the Ceramill Customer Center.



- _ Simple contact via telephone or C3 Service Portal - with return call directly from the specialist**
- _ Practical assistance during commissioning**
- _ Case-related problem solving**
- _ Answering questions via e-mail and telephone**
- _ Online support through desktop sharing - we show you the next steps live on your screen**

THE PRODUCTION CENTER FOR ALMOST ALL INDICATIONS AND MATERIALS: VERSATILE, PRECISE AND FAST

The prosthetic work still bears the handwriting of the dental technician - only the construction that is approved by him/her is also produced in the M-Center.

This is achieved by means of a perfectly coordinated system as well as by experienced and specialized dental technicians, including dental quality control, which is conducted during the production process.

The access data to the Ceramill M-Center are available from the Amann Girrbach customer portal - Ceramill Customer Center (C3). Simply register in the C3 under the section "Customer Account" and request the M-Center access data. Uploading of the constructions to the Ceramill M-Center is then performed via the CAD software Ceramill Mind or the Ceramill Upload Tool (can be downloaded in the C3 portal).



- _ A broad range of materials covers almost the entire spectrum of framework fabrication**
- _ A variety of indications (including crowns, bridges , abutments, telescopes, inlays/onlays, veneers, press-on technique, multi-pontic screw-retained constructions, bars, therapeutic splints, models)**
- _ Fast throughput times for good planning reliability**
- _ Lucrative discount scale system (discounts already starting from 11 units per month)**
- _ Customer portal C3: automated order management, delivery time and price overview, fast handling of complaints**
- _ Process reliability through optimally coordinated system (materials, software, hardware)**
- _ Trained dental technicians with many years of experience in CAD/CAM**
- _ Excellent service (support with framework design, setting of suitable design parameters, quick assistance in case of uncertainties)**

TECHNICAL SERVICE. YOUR POINT OF INFORMATION AND ACCEPTANCE FOR REPAIR AND SERVICE ISSUES

Our in-house service comes into play for small devices or in "tricky cases". They are also all ears for service inquiries about Amann Girrbach devices and systems.

Rental devices are available on request during the repair period in order to keep up the production process at all times.

During the repair period of Ceramill milling units you will receive discounted conditions at the Ceramill M-Center.



GENERAL INFORMATION

IN THIS CATALOGUE, THE PRODUCT INFORMATION IS RESTRICTED TO SOME ELEMENTARY FEATURES AND APPLICATIONS.

You will find more information in the according system brochures and/or leaflets.

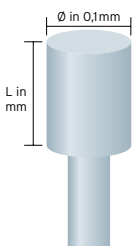
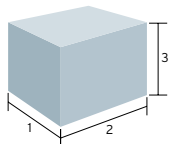

Technical data

In general, all dimensions are indicated in millimeters (mm) lined up in depth/length x width x height:

1. **depth**
2. **width**
3. **height**

If this is not the case, the differing indications are clearly defined (e.g. diameter = Ø, drilling, thickness, etc.)

Delivery volume

Introductory kits of systems or basic equipment for units are presented, on one hand, as complete set and, on the other hand, as single articles with different article numbers for repeat orders.

Replacement parts

... will be mentioned only in cases where there is high customer demand. All replacement parts are listed with article number in the unit's manual.

Changes, in the sense of better function, performance, service life and technical improvements are subject to alterations.

Terms and Condition

Please find our Terms and Conditions at

www.amanngirrbach.com

AUSTRIA (HEADQUARTERS)

Amann Girrbach AG
Koblach, Austria
Fon +43 5523 62333-105
austria@amanngirrbach.com

GERMANY

Amann Girrbach GmbH
Pforzheim, Germany
Fon +49 7231 957-100
germany@amanngirrbach.com

NORTH AMERICA

Amann Girrbach North America, LP
Charlotte, NC, U.S.A.
Fon +1 704 837 1404
america@amanngirrbach.com

BRASIL

Amann Girrbach Brasil LTDA
Curitiba, Brasil
Fon +55 41 3287 0897
brasil@amanngirrbach.com

ASIA

Amann Girrbach Asia PTE LTD.
Singapore, Asia
Fon +65 6592 5190
singapore@amanngirrbach.com

CHINA

Amann Girrbach China Co., Ltd.
Beijing, China
Fon +86 10 8886 6064
china@amanngirrbach.com